

TLC271, TLC271A, TLC271B LinCMOS™ PROGRAMMABLE LOW-POWER OPERATIONAL AMPLIFIERS

SLOS090D – NOVEMBER 1987 – REVISED MARCH 2001

- **Input Offset Voltage Drift . . . Typically 0.1 μ V/Month, Including the First 30 Days**
- **Wide Range of Supply Voltages Over Specified Temperature Range:**
 0°C to 70°C . . . 3 V to 16 V
 -40°C to 85°C . . . 4 V to 16 V
 -55°C to 125°C . . . 5 V to 16 V
- **Single-Supply Operation**
- **Common-Mode Input Voltage Range Extends Below the Negative Rail (C-Suffix and I-Suffix Types)**
- **Low Noise . . . 25 nV/ $\sqrt{\text{Hz}}$ Typically at $f = 1$ kHz (High-Bias Mode)**
- **Output Voltage Range Includes Negative Rail**
- **High Input Impedance . . . $10^{12} \Omega$ Typ**
- **ESD-Protection Circuitry**
- **Small-Outline Package Option Also Available in Tape and Reel**
- **Designed-In Latch-Up Immunity**

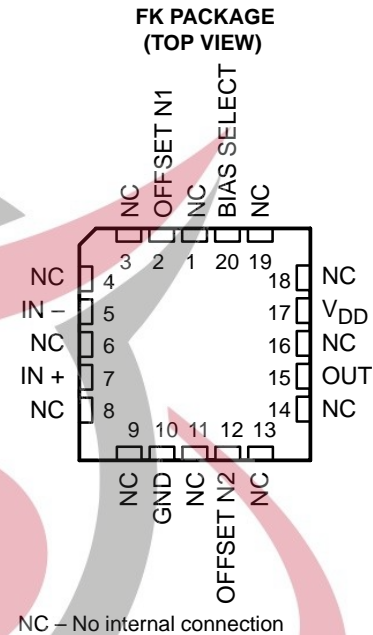
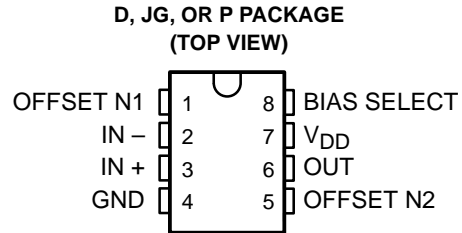

description

The TLC271 operational amplifier combines a wide range of input offset voltage grades with low offset voltage drift and high input impedance. In addition, the TLC271 offers a bias-select mode that allows the user to select the best combination of power dissipation and ac performance for a particular application. These devices use Texas Instruments silicon-gate LinCMOS™ technology, which provides offset voltage stability far exceeding the stability available with conventional metal-gate processes.

AVAILABLE OPTIONS

T _A	V _{IO} max AT 25°C	PACKAGE			
		SMALL OUTLINE (D)	CHIP CARRIER (FK)	CERAMIC DIP (JG)	PLASTIC DIP (P)
0°C to 70°C	2 mV	TLC271BCD	—	—	TLC271BCP
	5 mV	TLC271ACD	—	—	TLC271ACP
	10 mV	TLC271CD	—	—	TLC271CP
-40°C to 85°C	2 mV	TLC271BID	—	—	TLC271BIP
	5 mV	TLC271AID	—	—	TLC271AIP
	10 mV	TLC271ID	—	—	TLC271IP
-55°C to 125°C	10 mV	TLC271MD	TLC271MFK	TLC271MJG	TLC271MP

The D package is available taped and reeled. Add R suffix to the device type (e.g., TLC271BCDR).



Please be aware that an important notice concerning availability, standard warranty, and use in critical applications of Texas Instruments semiconductor products and disclaimers thereto appears at the end of this data sheet.

LinCMOS is a trademark of Texas Instruments.

PRODUCTION DATA information is current as of publication date. Products conform to specifications per the terms of Texas Instruments standard warranty. Production processing does not necessarily include testing of all parameters.

**TEXAS
INSTRUMENTS**

POST OFFICE BOX 655303 • DALLAS, TEXAS 75265

Copyright © 2001, Texas Instruments Incorporated

TLC271, TLC271A, TLC271B
LinCMOS™ PROGRAMMABLE LOW-POWER
OPERATIONAL AMPLIFIERS

SLOS090D – NOVEMBER 1987 – REVISED MARCH 2001

DEVICE FEATURES

PARAMETER†	BIAS-SELECT MODE			UNIT
	HIGH	MEDIUM	LOW	
P _D	3375	525	50	μW
SR	3.6	0.4	0.03	V/μs
V _n	25	32	68	nV/√Hz
B ₁	1.7	0.5	0.09	MHz
A _{VD}	23	170	480	V/mV

† Typical at V_{DD} = 5 V, T_A = 25°C

description (continued)

Using the bias-select option, these cost-effective devices can be programmed to span a wide range of applications that previously required BiFET, NFET, or bipolar technology. Three offset voltage grades are available (C-suffix and I-suffix types), ranging from the low-cost TLC271 (10 mV) to the TLC271B (2 mV) low-offset version. The extremely high input impedance and low bias currents, in conjunction with good common-mode rejection and supply voltage rejection, make these devices a good choice for new state-of-the-art designs as well as for upgrading existing designs.

In general, many features associated with bipolar technology are available in LinCMOS™ operational amplifiers, without the power penalties of bipolar technology. General applications such as transducer interfacing, analog calculations, amplifier blocks, active filters, and signal buffering are all easily designed with the TLC271. The devices also exhibit low-voltage single-supply operation, making them ideally suited for remote and inaccessible battery-powered applications. The common-mode input voltage range includes the negative rail.

A wide range of packaging options is available, including small-outline and chip-carrier versions for high-density system applications.

The device inputs and output are designed to withstand –100-mA surge currents without sustaining latch-up.

The TLC271 incorporates internal ESD-protection circuits that prevent functional failures at voltages up to 2000 V as tested under MIL-STD-883C, Method 3015.2; however, care should be exercised in handling these devices as exposure to ESD may result in the degradation of the device parametric performance.

The C-suffix devices are characterized for operation from 0°C to 70°C. The I-suffix devices are characterized for operation from –40°C to 85°C. The M-suffix devices are characterized for operation over the full military temperature range of –55°C to 125°C.

bias-select feature

The TLC271 offers a bias-select feature that allows the user to select any one of three bias levels depending on the level of performance desired. The tradeoffs between bias levels involve ac performance and power dissipation (see Table 1).

Table 1. Effect of Bias Selection on Performance

TYPICAL PARAMETER VALUES T _A = 25°C, V _{DD} = 5 V		MODE			UNIT
		HIGH BIAS R _L = 10 kΩ	MEDIUM BIAS R _L = 100 kΩ	LOW BIAS R _L = 1 MΩ	
P _D	Power dissipation	3.4	0.5	0.05	mW
SR	Slew rate	3.6	0.4	0.03	V/μs
V _n	Equivalent input noise voltage at f = 1 kHz	25	32	68	nV/√Hz
B ₁	Unity-gain bandwidth	1.7	0.5	0.09	MHz
φ _m	Phase margin	46°	40°	34°	
A _{VD}	Large-signal differential voltage amplification	23	170	480	V/mV



bias selection

Bias selection is achieved by connecting the bias select pin to one of three voltage levels (see Figure 1). For medium-bias applications, it is recommended that the bias select pin be connected to the midpoint between the supply rails. This procedure is simple in split-supply applications, since this point is ground. In single-supply applications, the medium-bias mode necessitates using a voltage divider as indicated in Figure 1. The use of large-value resistors in the voltage divider reduces the current drain of the divider from the supply line. However, large-value resistors used in conjunction with a large-value capacitor require significant time to charge up to the supply midpoint after the supply is switched on. A voltage other than the midpoint can be used if it is within the voltages specified in Figure 1.

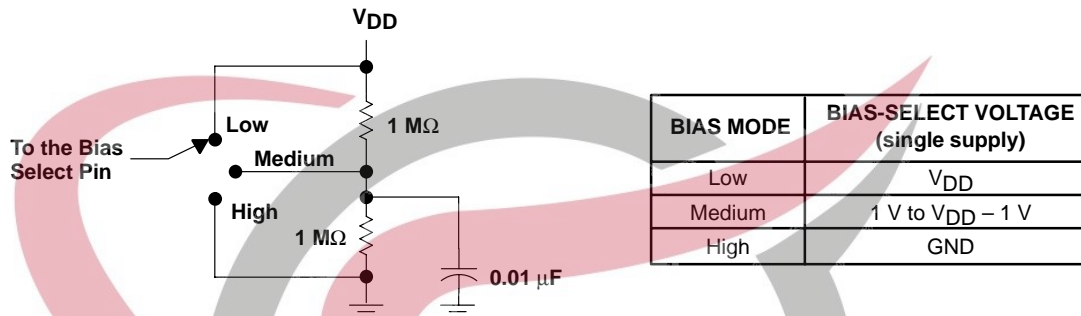

Figure 1. Bias Selection for Single-Supply Applications

high-bias mode

In the high-bias mode, the TLC271 series features low offset voltage drift, high input impedance, and low noise. Speed in this mode approaches that of BiFET devices but at only a fraction of the power dissipation. Unity-gain bandwidth is typically greater than 1 MHz.

medium-bias mode

The TLC271 in the medium-bias mode features low offset voltage drift, high input impedance, and low noise. Speed in this mode is similar to general-purpose bipolar devices but power dissipation is only a fraction of that consumed by bipolar devices.

SKYTECH
 ELECTRONIC

TLC271, TLC271A, TLC271B

LinCMOS™ PROGRAMMABLE LOW-POWER OPERATIONAL AMPLIFIERS

SLOS090D – NOVEMBER 1987 – REVISED MARCH 2001

low-bias mode

In the low-bias mode, the TLC271 features low offset voltage drift, high input impedance, extremely low power consumption, and high differential voltage gain.

ORDER OF CONTENTS

TOPIC	BIAS MODE
schematic	all
absolute maximum ratings	all
recommended operating conditions	all
electrical characteristics operating characteristics typical characteristics	high (Figures 2 – 33)
electrical characteristics operating characteristics typical characteristics	medium (Figures 34 – 65)
electrical characteristics operating characteristics typical characteristics	low (Figures 66 – 97)
parameter measurement information	all
application information	all

equivalent schematic

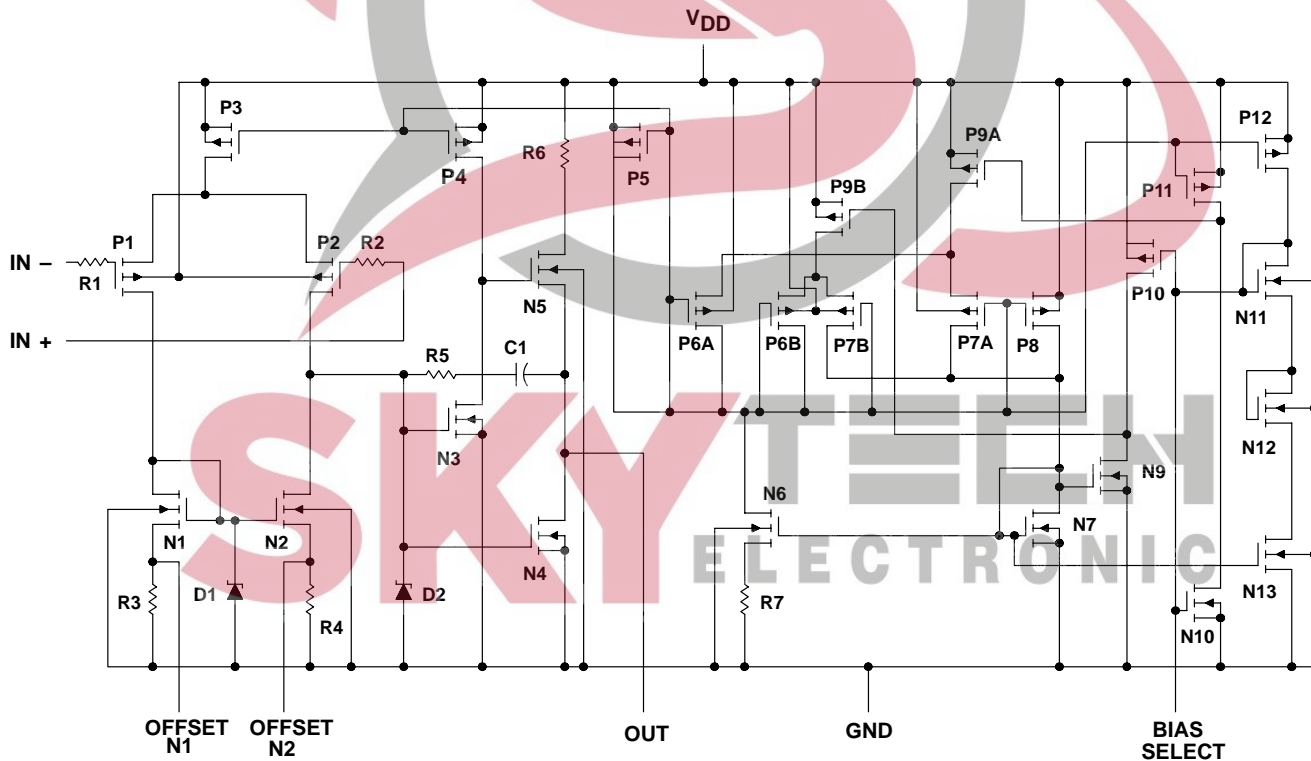

absolute maximum ratings over operating free-air temperature (unless otherwise noted)†

Supply voltage, V_{DD} (see Note 1)	18 V
Differential input voltage, V_{ID} (see Note 2)	$\pm V_{DD}$
Input voltage range, V_I (any input)	–0.3 V to V_{DD}
Input current, I_I	± 5 mA
Output current, I_O	± 30 mA
Duration of short-circuit current at (or below) 25°C (see Note 3)	Unlimited
Continuous total dissipation	See Dissipation Rating Table
Operating free-air temperature, T_A : C suffix	0°C to 70°C
I suffix	–40°C to 85°C
M suffix	–55°C to 125°C
Storage temperature range	–65°C to 150°C
Case temperature for 60 seconds: FK package	260°C
Lead temperature 1,6 mm (1/16 inch) from case for 10 seconds: D or P package	260°C
Lead temperature 1,6 mm (1/16 inch) from case for 60 seconds: JG package	300°C

† Stresses beyond those listed under “absolute maximum ratings” may cause permanent damage to the device. These are stress ratings only, and functional operation of the device at these or any other conditions beyond those indicated under “recommended operating conditions” is not implied. Exposure to absolute-maximum-rated conditions for extended periods may affect device reliability.

- NOTES:
1. All voltage values, except differential voltages, are with respect to network ground.
 2. Differential voltages are at $IN+$ with respect to $IN-$.
 3. The output may be shorted to either supply. Temperature and/or supply voltages must be limited to ensure that the maximum dissipation rating is not exceeded (see application section).

DISSIPATION RATING TABLE

PACKAGE	$T_A \leq 25^\circ\text{C}$	DERATING FACTOR ABOVE $T_A = 25^\circ\text{C}$	$T_A = 70^\circ\text{C}$	$T_A = 85^\circ\text{C}$	$T_A = 125^\circ\text{C}$
	POWER RATING		POWER RATING	POWER RATING	POWER RATING
D	725 mW	5.8 mW/°C	464 mW	377 mW	145 mW
FK	1375 mW	11.0 mW/°C	880 mW	715 mW	275 mW
JG	1050 mW	8.4 mW/°C	672 mW	546 mW	210 mW
P	1000 mW	8.0 mW/°C	640 mW	520 mW	200 mW

recommended operating conditions

	C SUFFIX		I SUFFIX		M SUFFIX		UNIT
	MIN	MAX	MIN	MAX	MIN	MAX	
Supply voltage, V_{DD}	3	16	4	16	5	16	V
Common-mode input voltage, V_{IC}	$V_{DD} = 5$ V		–0.2	3.5	0	3.5	V
	$V_{DD} = 10$ V		–0.2	8.5	0	8.5	
Operating free-air temperature, T_A	0	70	–40	85	–55	125	°C

TLC271, TLC271A, TLC271B
LinCMOS™ PROGRAMMABLE LOW-POWER
OPERATIONAL AMPLIFIERS

SLOS090D – NOVEMBER 1987 – REVISED MARCH 2001

HIGH-BIAS MODE

electrical characteristics at specified free-air temperature (unless otherwise noted)

PARAMETER		TEST CONDITIONS	T _A †	TLC271C, TLC271AC, TLC271BC						UNIT
				V _{DD} = 5 V			V _{DD} = 10 V			
				MIN	TYP	MAX	MIN	TYP	MAX	
V _{IO}	Input offset voltage	V _O = 1.4 V, V _{IC} = 0 V, R _S = 50 Ω, R _L = 10 kΩ	25°C	1.1		10	1.1		10	mV
			Full range			12			12	
			25°C	0.9		5	0.9		5	
			Full range			6.5			6.5	
			25°C	0.34		2	0.39		2	
	TLC271BC		Full range			3			3	
α _{VIO}	Average temperature coefficient of input offset voltage		25°C to 70°C	1.8			2		μV/°C	
I _{IO}	Input offset current (see Note 4)	V _O = V _{DD} /2, V _{IC} = V _{DD} /2	25°C	0.1	60	0.1	60	pA		
			70°C	7	300	7	300			
I _{IB}	Input bias current (see Note 4)	V _O = V _{DD} /2, V _{IC} = V _{DD} /2	25°C	0.6	60	0.7	60	pA		
			70°C	40	600	50	600			
V _{ICR}	Common-mode input voltage range (see Note 5)		25°C	-0.2 to 4	-0.3 to 4.2	-0.2 to 9	-0.3 to 9.2	V		
			Full range	-0.2 to 3.5		-0.2 to 8.5		V		
V _{OH}	High-level output voltage	V _{ID} = 100 mV, R _L = 10 kΩ	25°C	3.2	3.8	8	8.5	V		
			0°C	3	3.8	7.8	8.5			
			70°C	3	3.8	7.8	8.4			
V _{OL}	Low-level output voltage	V _{ID} = -100 mV, I _{OL} = 0	25°C	0	50	0	50	mV		
			0°C	0	50	0	50			
			70°C	0	50	0	50			
A _{VD}	Large-signal differential voltage amplification	R _L = 10 kΩ, See Note 6	25°C	5	23	10	36	V/mV		
			0°C	4	27	7.5	42			
			70°C	4	20	7.5	32			
CMRR	Common-mode rejection ratio	V _{IC} = V _{ICRmin}	25°C	65	80	65	85	dB		
			0°C	60	84	60	88			
			70°C	60	85	60	88			
k _{SVR}	Supply-voltage rejection ratio (ΔV _{DD} /ΔV _{IO})	V _{DD} = 5 V to 10 V V _O = 1.4 V	25°C	65	95	65	95	dB		
			0°C	60	94	60	94			
			70°C	60	96	60	96			
I _{I(SEL)}	Input current (BIAS SELECT)	V _{I(SEL)} = 0	25°C	-1.4		-1.9		μA		
I _{DD}	Supply current	V _O = V _{DD} /2, V _{IC} = V _{DD} /2, No load	25°C	675	1600	950	2000	μA		
			0°C	775	1800	1125	2200			
			70°C	575	1300	750	1700			

† Full range is 0°C to 70°C.

NOTES: 4. The typical values of input bias current and input offset current below 5 pA were determined mathematically.

5. This range also applies to each input individually.

6. At V_{DD} = 5 V, V_O = 0.25 V to 2 V; at V_{DD} = 10 V, V_O = 1 V to 6 V.



HIGH-BIAS MODE

electrical characteristics at specified free-air temperature (unless otherwise noted)

PARAMETER	TEST CONDITIONS	TA†	TLC271I, TLC271AI, TLC271BI						UNIT		
			VDD = 5 V			VDD = 10 V					
			MIN	TYP	MAX	MIN	TYP	MAX			
VIO	Input offset voltage	TLC271I	VO = 1.4 V, VIC = 0 V, RS = 50 Ω, RL = 10 kΩ	25°C	1.1	10		1.1	10	mV	
				Full range				13	13		
				25°C	0.9	5		0.9	5		
				Full range				7	7		
VIO	Input offset voltage	TLC271AI	VO = 1.4 V, VIC = 0 V, RS = 50 Ω, RL = 10 kΩ	25°C	0.34	2		0.39	2	mV	
				Full range				3.5	3.5		
				25°C	0.34	2		0.39	2		
				Full range				3.5	3.5		
αVIO	Average temperature coefficient of input offset voltage	TLC271BI	VO = 1.4 V, VIC = 0 V, RS = 50 Ω, RL = 10 kΩ	25°C to 85°C	1.8			2		μV/°C	
IIO	Input offset current (see Note 4)	TLC271BI	VO = VDD/2, VIC = VDD/2	25°C	0.1	60		0.1	60	pA	
				85°C	24	1000		26	1000		
IIB	Input bias current (see Note 4)	TLC271BI	VO = VDD/2, VIC = VDD/2	25°C	0.6	60		0.7	60	pA	
				85°C	200	2000		220	2000		
VICR	Common-mode input voltage range (see Note 5)	TLC271BI	VO = VDD/2, VIC = VDD/2	25°C	-0.2 to 4	-0.3 to 4.2		-0.2 to 9	-0.3 to 9.2	V	
				Full range	-0.2 to 3.5			-0.2 to 8.5			
VOH	High-level output voltage	TLC271BI	VID = 100 mV, RL = 10 kΩ	25°C	3.2	3.8		8	8.5	V	
				-40°C	3	3.8		7.8	8.5		
				85°C	3	3.8		7.8	8.5		
VOL	Low-level output voltage	TLC271BI	VID = -100 mV, IOL = 0	25°C		0	50		0	50	mV
				-40°C		0	50		0	50	
				85°C		0	50		0	50	
AVD	Large-signal differential voltage amplification	TLC271BI	RL = 10 kΩ, See Note 6	25°C	5	23		10	36	V/mV	
				-40°C	3.5	32		7	46		
				85°C	3.5	19		7	31		
CMRR	Common-mode rejection ratio	TLC271BI	VIC = VICRmin	25°C	65	80		65	85	dB	
				-40°C	60	81		60	87		
				85°C	60	86		60	88		
kSVR	Supply-voltage rejection ratio (ΔVDD/ΔVIO)	TLC271BI	VDD = 5 V to 10 V VO = 1.4 V	25°C	65	95		65	95	dB	
				-40°C	60	92		60	92		
				85°C	60	96		60	96		
II(SEL)	Input current (BIAS SELECT)	TLC271BI	VO = 1.4 V	25°C	-1.4			-1.9	μA		
IDD	Supply current	TLC271BI	VO = VDD/2, VIC = VDD/2, No load	25°C	675	1600		950	2000	μA	
				-40°C	950	2200		1375	2500		
				85°C	525	1200		725	1600		

† Full range is -40°C to 85°C.

- NOTES:
- The typical values of input bias current and input offset current below 5 pA were determined mathematically.
 - This range also applies to each input individually.
 - At VDD = 5 V, VO = 0.25 V to 2 V; at VDD = 10 V, VO = 1 V to 6 V.

TLC271, TLC271A, TLC271B
LinCMOS™ PROGRAMMABLE LOW-POWER
OPERATIONAL AMPLIFIERS

SLOS090D – NOVEMBER 1987 – REVISED MARCH 2001

HIGH-BIAS MODE

electrical characteristics at specified free-air temperature (unless otherwise noted)

PARAMETER	TEST CONDITIONS	T _A †	TLC271M						UNIT
			V _{DD} = 5 V			V _{DD} = 10 V			
			MIN	TYP	MAX	MIN	TYP	MAX	
V _{IO} Input offset voltage	V _O = 1.4 V, V _{IC} = 0 V, R _S = 50 Ω, R _L = 10 kΩ	25°C		1.1	10		1.1	10	mV
		Full range			12		12		
α _{VIO} Average temperature coefficient of input offset voltage		25°C to 125°C		2.1			2.2		μV/°C
I _{IO} Input offset current (see Note 4)	V _O = V _{DD} /2, V _{IC} = V _{DD} /2	25°C		0.1	60		0.1	60	pA
		125°C		1.4	15		1.8	15	nA
I _{IB} Input bias current (see Note 4)	V _O = V _{DD} /2, V _{IC} = V _{DD} /2	25°C		0.6	60		0.7	60	pA
		125°C		9	35		10	35	nA
V _{ICR} Common-mode input voltage range (see Note 5)		25°C	0 to 4	-0.3 to 4.2		0 to 9	-0.3 to 9.2		V
		Full range	0 to 3.5		0 to 8.5				
V _{OH} High-level output voltage	V _{ID} = 100 mV, R _L = 10 kΩ	25°C	3.2	3.8		8	8.5		V
		-55°C	3	3.8		7.8	8.5		
		125°C	3	3.8		7.8	8.4		
V _{OL} Low-level output voltage	V _{ID} = -100 mV, I _{OL} = 0	25°C		0	50		0	50	mV
		-55°C		0	50		0	50	
		125°C		0	50		0	50	
A _{VD} Large-signal differential voltage amplification	R _L = 10 kΩ, See Note 6	25°C	5	23		10	36		V/mV
		-55°C	3.5	35		7	50		
		125°C	3.5	16		7	27		
CMRR Common-mode rejection ratio	V _{IC} = V _{ICRmin}	25°C	65	80		65	85		dB
		-55°C	60	81		60	87		
		125°C	60	84		60	86		
k _{SVR} Supply-voltage rejection ratio (ΔV _{DD} /ΔV _{IO})	V _{DD} = 5 V to 10 V V _O = 1.4 V	25°C	65	95		65	95		dB
		-55°C	60	90		60	90		
		125°C	60	97		60	97		
I _{I(SEL)} Input current (BIAS SELECT)	V _{I(SEL)} = 0	25°C		-1.4		-1.9		μA	
I _{DD} Supply current	V _O = V _{DD} /2, V _{IC} = V _{DD} /2, No load	25°C		675	1600		950	2000	μA
		-55°C		1000	2500		1475	3000	
		125°C		475	1100		625	1400	

† Full range is -55°C to 125°C.

NOTES: 4. The typical values of input bias current and input offset current below 5 pA were determined mathematically.

5. This range also applies to each input individually.

6. At V_{DD} = 5 V, V_O = 0.25 V to 2 V; at V_{DD} = 10 V, V_O = 1 V to 6 V.



HIGH-BIAS MODE

operating characteristics at specified free-air temperature, $V_{DD} = 5\text{ V}$

PARAMETER	TEST CONDITIONS	T_A	TLC271C, TLC271AC, TLC271BC			UNIT
			MIN	TYP	MAX	
SR Slew rate at unity gain	$R_L = 10\text{ k}\Omega$, $C_L = 20\text{ pF}$, See Figure 98	$V_{I(PP)} = 1\text{ V}$	25°C	3.6		V/ μ s
			0°C	4		
			70°C	3		
		$V_{I(PP)} = 2.5\text{ V}$	25°C	2.9		
			0°C	3.1		
			70°C	2.5		
V_n Equivalent input noise voltage	$f = 1\text{ kHz}$, See Figure 99	$R_S = 20\ \Omega$, 25°C	25		nV/ $\sqrt{\text{Hz}}$	
B_{OM} Maximum output-swing bandwidth	$V_O = V_{OH}$, $R_L = 10\text{ k}\Omega$,	$C_L = 20\text{ pF}$, See Figure 98	25°C	320		kHz
			0°C	340		
			70°C	260		
B_1 Unity-gain bandwidth	$V_I = 10\text{ mV}$, See Figure 100	$C_L = 20\text{ pF}$,	25°C	1.7		MHz
			0°C	2		
			70°C	1.3		
ϕ_m Phase margin	$V_I = 10\text{ mV}$, $C_L = 20\text{ pF}$,	$f = B_1$, See Figure 100	25°C	46°		
			0°C	47°		
			70°C	44°		

operating characteristics at specified free-air temperature, $V_{DD} = 10\text{ V}$

PARAMETER	TEST CONDITIONS	T_A	TLC271C, TLC271AC, TLC271BC			UNIT
			MIN	TYP	MAX	
SR Slew rate at unity gain	$R_L = 10\text{ k}\Omega$, $C_L = 20\text{ pF}$, See Figure 98	$V_{I(PP)} = 1\text{ V}$	25°C	5.3		V/ μ s
			0°C	5.9		
			70°C	4.3		
		$V_{I(PP)} = 5.5\text{ V}$	25°C	4.6		
			0°C	5.1		
			70°C	3.8		
V_n Equivalent input noise voltage	$f = 1\text{ kHz}$, See Figure 99	$R_S = 20\ \Omega$, 25°C	25		nV/ $\sqrt{\text{Hz}}$	
B_{OM} Maximum output-swing bandwidth	$V_O = V_{OH}$, $R_L = 10\text{ k}\Omega$,	$C_L = 20\text{ pF}$, See Figure 98	25°C	200		kHz
			0°C	220		
			70°C	140		
B_1 Unity-gain bandwidth	$V_I = 10\text{ mV}$, See Figure 100	$C_L = 20\text{ pF}$,	25°C	2.2		MHz
			0°C	2.5		
			70°C	1.8		
ϕ_m Phase margin	$f = B_1$, $C_L = 20\text{ pF}$,	$V_I = 10\text{ mV}$, See Figure 100	25°C	49°		
			0°C	50°		
			70°C	46°		

TLC271, TLC271A, TLC271B
LinCMOS™ PROGRAMMABLE LOW-POWER
OPERATIONAL AMPLIFIERS

SLOS090D – NOVEMBER 1987 – REVISED MARCH 2001

HIGH-BIAS MODE

operating characteristics at specified free-air temperature, $V_{DD} = 5\text{ V}$

PARAMETER	TEST CONDITIONS	T_A	TLC271I, TLC271AI, TLC271BI			UNIT
			MIN	TYP	MAX	
SR Slew rate at unity gain	$R_L = 10\text{ k}\Omega$, $C_L = 20\text{ pF}$, See Figure 98	$V_{I(PP)} = 1\text{ V}$	25°C	3.6		V/ μ s
			-40°C	4.5		
			85°C	2.8		
		$V_{I(PP)} = 2.5\text{ V}$	25°C	2.9		
			-40°C	3.5		
			85°C	2.3		
V_n Equivalent input noise voltage	$f = 1\text{ kHz}$, See Figure 99	$R_S = 20\ \Omega$, 25°C	25		nV/ $\sqrt{\text{Hz}}$	
BOM Maximum output-swing bandwidth	$V_O = V_{OH}$, $R_L = 10\text{ k}\Omega$, $C_L = 20\text{ pF}$, See Figure 98	25°C	320		kHz	
		-40°C	380			
		85°C	250			
B ₁ Unity-gain bandwidth	$V_I = 10\text{ mV}$, See Figure 100	$C_L = 20\text{ pF}$, 25°C	1.7		MHz	
			-40°C	2.6		
			85°C	1.2		
ϕ_m Phase margin	$V_I = 10\text{ mV}$, $C_L = 20\text{ pF}$, $f = B_1$, See Figure 100	25°C	46°			
		-40°C	49°			
		85°C	43°			

operating characteristics at specified free-air temperature, $V_{DD} = 10\text{ V}$

PARAMETER	TEST CONDITIONS	T_A	TLC271I, TLC271AI, TLC271BI			UNIT
			MIN	TYP	MAX	
SR Slew rate at unity gain	$R_L = 10\text{ k}\Omega$, $C_L = 20\text{ pF}$, See Figure 98	$V_{I(PP)} = 1\text{ V}$	25°C	5.3		V/ μ s
			-40°C	6.8		
			85°C	4		
		$V_{I(PP)} = 5.5\text{ V}$	25°C	4.6		
			-40°C	5.8		
			85°C	3.5		
V_n Equivalent input noise voltage	$f = 1\text{ kHz}$, See Figure 99	$R_S = 20\ \Omega$, 25°C	25		nV/ $\sqrt{\text{Hz}}$	
BOM Maximum output-swing bandwidth	$V_O = V_{OH}$, $R_L = 10\text{ k}\Omega$, $C_L = 20\text{ pF}$, See Figure 98	25°C	200		kHz	
		-40°C	260			
		85°C	130			
B ₁ Unity-gain bandwidth	$V_I = 10\text{ mV}$, See Figure 100	$C_L = 20\text{ pF}$, 25°C	2.2		MHz	
			-40°C	3.1		
			85°C	1.7		
ϕ_m Phase margin	$V_I = 10\text{ mV}$, $C_L = 20\text{ pF}$, $f = B_1$, See Figure 100	25°C	49°			
		-40°C	52°			
		85°C	46°			



HIGH-BIAS MODE

operating characteristics at specified free-air temperature, $V_{DD} = 5\text{ V}$

PARAMETER	TEST CONDITIONS	T_A	TLC271M			UNIT
			MIN	TYP	MAX	
SR Slew rate at unity gain	$R_L = 10\text{ k}\Omega$, $C_L = 20\text{ pF}$, See Figure 98	$V_{I(PP)} = 1\text{ V}$	25°C	3.6		V/ μ s
			-55°C	4.7		
			125°C	2.3		
		$V_{I(PP)} = 2.5\text{ V}$	25°C	2.9		
			-55°C	3.7		
			125°C	2		
V_n Equivalent input noise voltage	$f = 1\text{ kHz}$, See Figure 99	$R_S = 20\ \Omega$	25°C	25		nV/ $\sqrt{\text{Hz}}$
B_{OM} Maximum output-swing bandwidth	$V_O = V_{OH}$, $R_L = 10\text{ k}\Omega$	$C_L = 20\text{ pF}$, See Figure 98	25°C	320		kHz
			-55°C	400		
			125°C	230		
B_1 Unity-gain bandwidth	$V_I = 10\text{ mV}$, See Figure 100	$C_L = 20\text{ pF}$	25°C	1.7		MHz
			-55°C	2.9		
			125°C	1.1		
ϕ_m Phase margin	$V_I = 10\text{ mV}$, $C_L = 20\text{ pF}$	$f = B_1$, See Figure 100	25°C	46°		
			-55°C	49°		
			125°C	41°		

operating characteristics at specified free-air temperature, $V_{DD} = 10\text{ V}$

PARAMETER	TEST CONDITIONS	T_A	TLC271M			UNIT
			MIN	TYP	MAX	
SR Slew rate at unity gain	$R_L = 10\text{ k}\Omega$, $C_L = 20\text{ pF}$, See Figure 98	$V_{I(PP)} = 1\text{ V}$	25°C	5.3		V/ μ s
			-55°C	7.1		
			125°C	3.1		
		$V_{I(PP)} = 5.5\text{ V}$	25°C	4.6		
			-55°C	6.1		
			125°C	2.7		
V_n Equivalent input noise voltage	$f = 1\text{ kHz}$, See Figure 99	$R_S = 20\ \Omega$	25°C	25		nV/ $\sqrt{\text{Hz}}$
B_{OM} Maximum output-swing bandwidth	$V_O = V_{OH}$, $R_L = 10\text{ k}\Omega$	$C_L = 20\text{ pF}$, See Figure 98	25°C	200		kHz
			-55°C	280		
			125°C	110		
B_1 Unity-gain bandwidth	$V_I = 10\text{ mV}$, See Figure 100	$C_L = 20\text{ pF}$	25°C	2.2		MHz
			-55°C	3.4		
			125°C	1.6		
ϕ_m Phase margin	$f = B_1$, $C_L = 20\text{ pF}$	$V_I = 10\text{ mV}$, See Figure 100	25°C	49°		
			-55°C	52°		
			125°C	44°		

TLC271, TLC271A, TLC271B
LinCMOS™ PROGRAMMABLE LOW-POWER
OPERATIONAL AMPLIFIERS

SLOS090D – NOVEMBER 1987 – REVISED MARCH 2001

TYPICAL CHARACTERISTICS (HIGH-BIAS MODE)

Table of Graphs

		FIGURE	
V_{IO}	Input offset voltage	Distribution	2, 3
α_{VIO}	Temperature coefficient	Distribution	4, 5
V_{OH}	High-level output voltage	vs High-level output current vs Supply voltage vs Free-air temperature	6, 7 8 9
V_{OL}	Low-level output voltage	vs Common-mode input voltage vs Differential input voltage vs Free-air temperature vs Low-level output current	10, 11 12 13 14, 15
A_{VD}	Large-signal differential voltage amplification	vs Supply voltage vs Free-air temperature vs Frequency	16 17 28, 29
I_{IB}	Input bias current	vs Free-air temperature	18
I_{IO}	Input offset current	vs Free-air temperature	18
V_{IC}	Common-mode input voltage	vs Supply voltage	19
I_{DD}	Supply current	vs Supply voltage vs Free-air temperature	20 21
SR	Slew rate	vs Supply voltage vs Free-air temperature	22 23
	Bias-select current	vs Supply voltage	24
$V_{O(PP)}$	Maximum peak-to-peak output voltage	vs Frequency	25
B_1	Unity-gain bandwidth	vs Free-air temperature vs Supply voltage	26 27
A_{VD}	Large-signal differential voltage amplification	vs Frequency	28, 29
ϕ_m	Phase margin	vs Supply voltage vs Free-air temperature vs Capacitive load	30 31 32
V_n	Equivalent input noise voltage	vs Frequency	33
	Phase shift	vs Frequency	28, 29



POST OFFICE BOX 655303 • DALLAS, TEXAS 75265

TYPICAL CHARACTERISTICS (HIGH-BIAS MODE)†

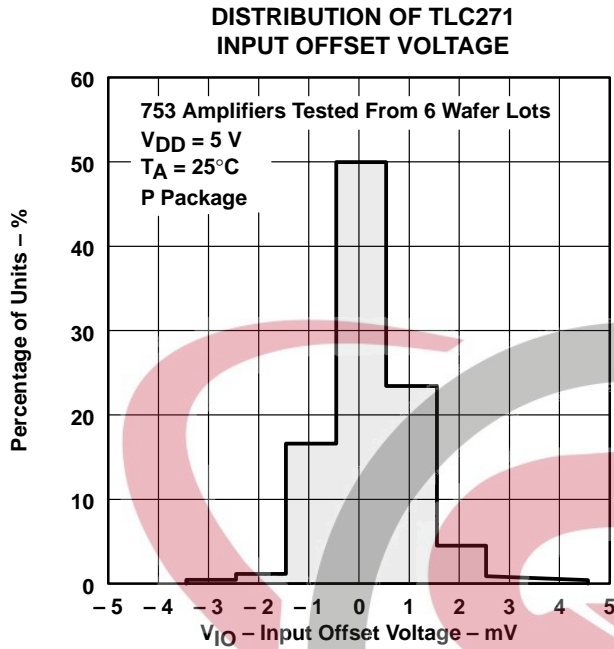

Figure 2

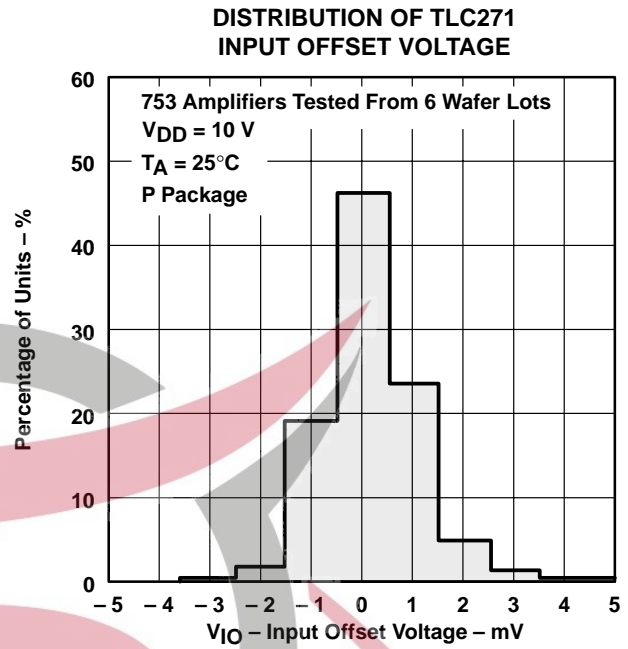

Figure 3

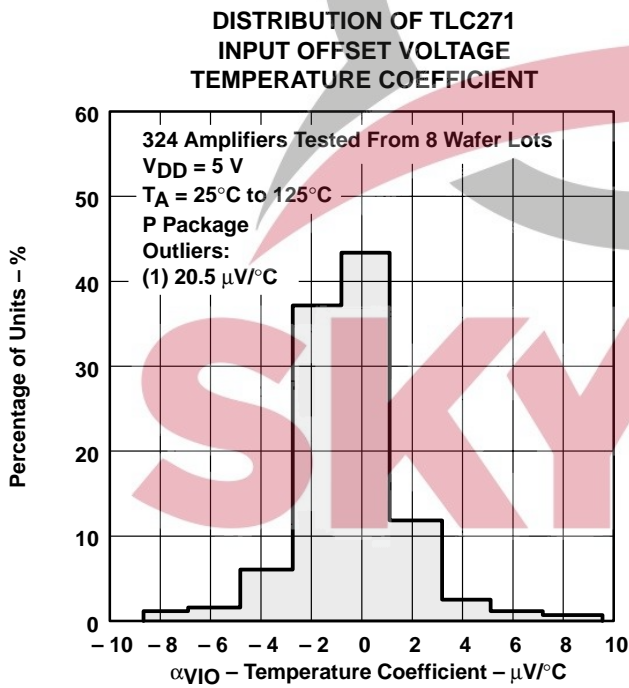

Figure 4

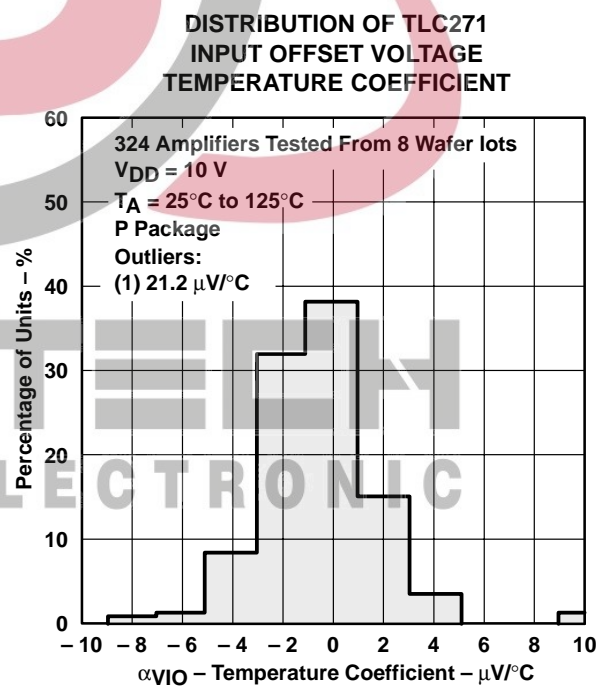

Figure 5

† Data at high and low temperatures are applicable only within the rated operating free-air temperature ranges of the various devices.

TYPICAL CHARACTERISTICS (HIGH-BIAS MODE)†

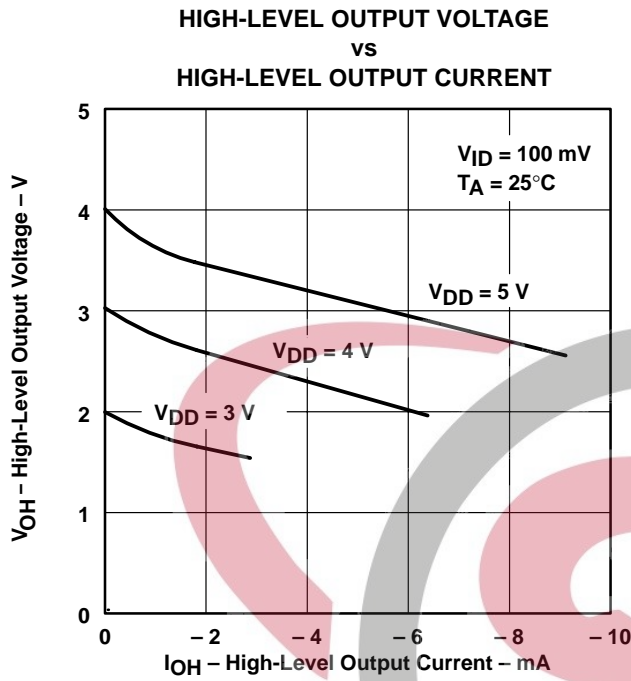

Figure 6

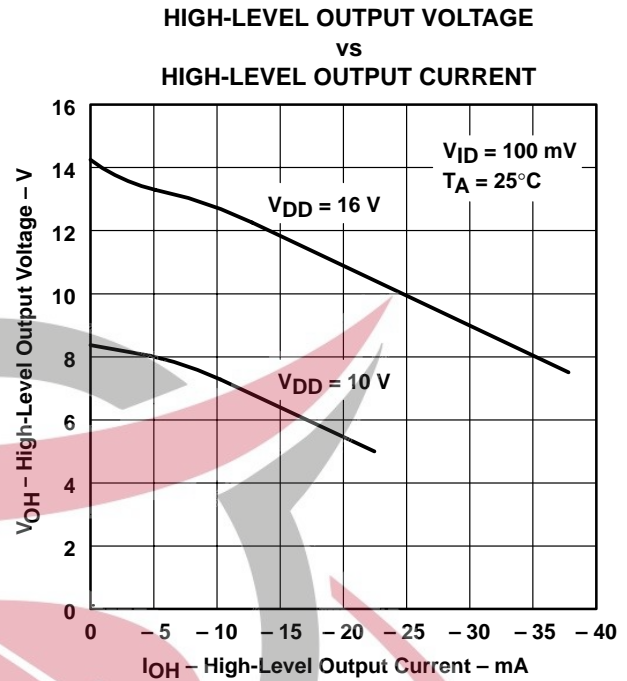

Figure 7

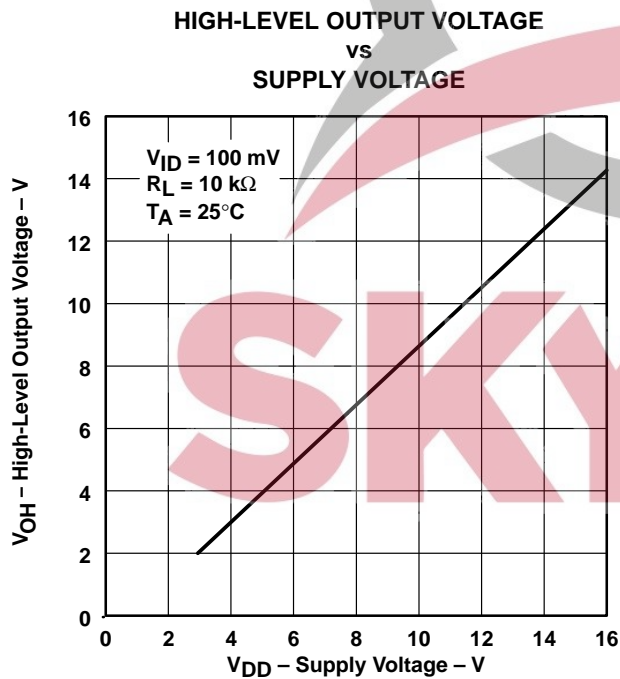

Figure 8

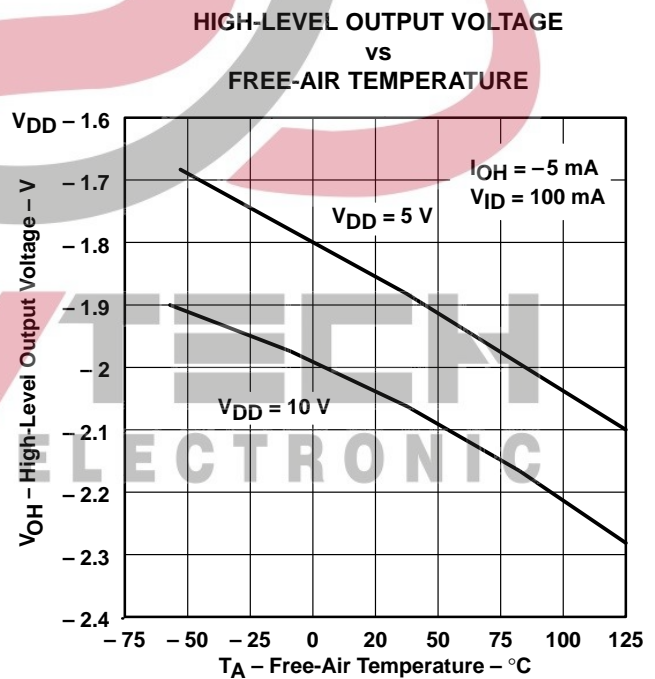

Figure 9

† Data at high and low temperatures are applicable only within the rated operating free-air temperature ranges of the various devices.

TYPICAL CHARACTERISTICS (HIGH-BIAS MODE)†

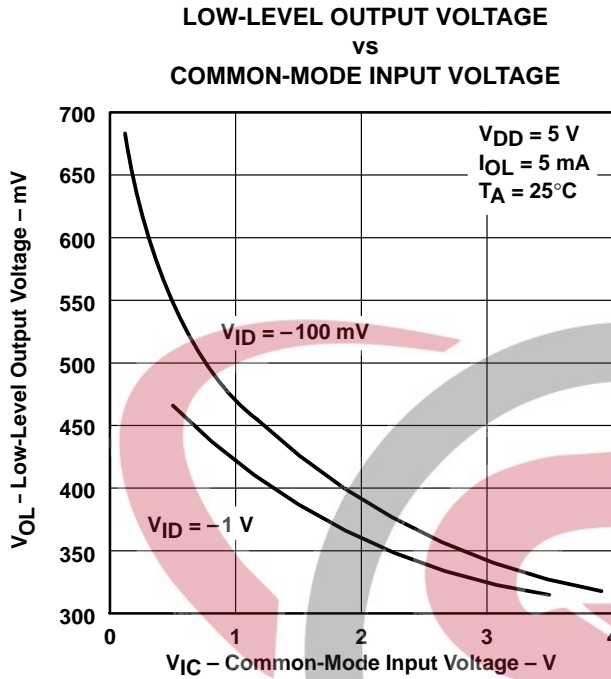

Figure 10

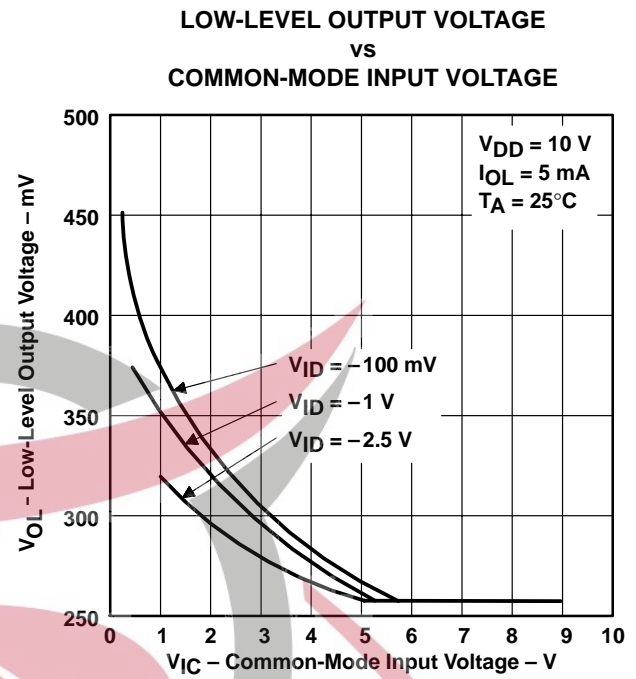

Figure 11

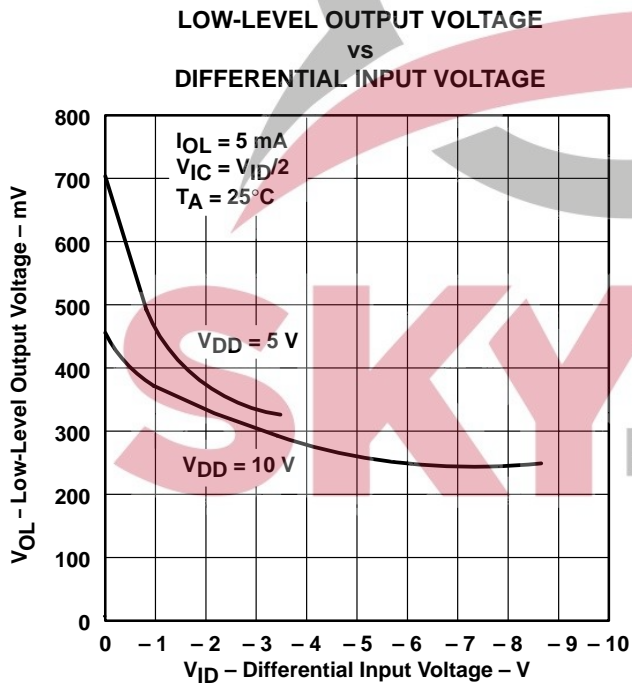

Figure 12

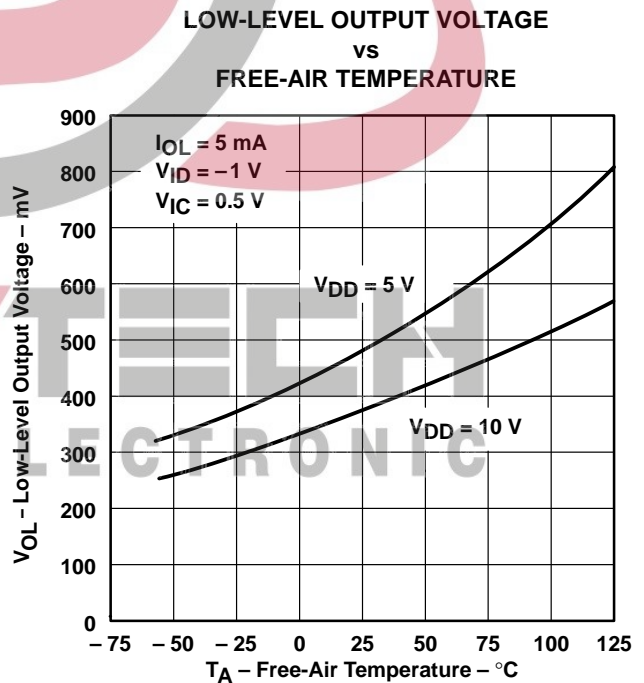

Figure 13

† Data at high and low temperatures are applicable only within the rated operating free-air temperature ranges of the various devices.

TYPICAL CHARACTERISTICS (HIGH-BIAS MODE)†

**LOW-LEVEL OUTPUT VOLTAGE
 vs
 LOW-LEVEL OUTPUT CURRENT**

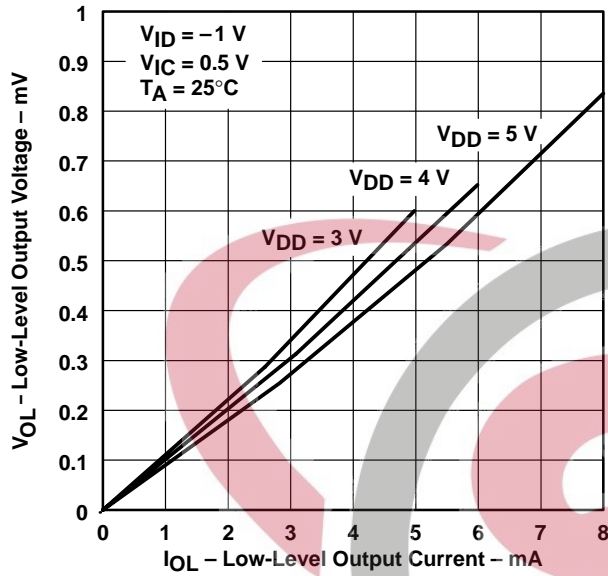

Figure 14

**LOW-LEVEL OUTPUT VOLTAGE
 vs
 LOW-LEVEL OUTPUT CURRENT**

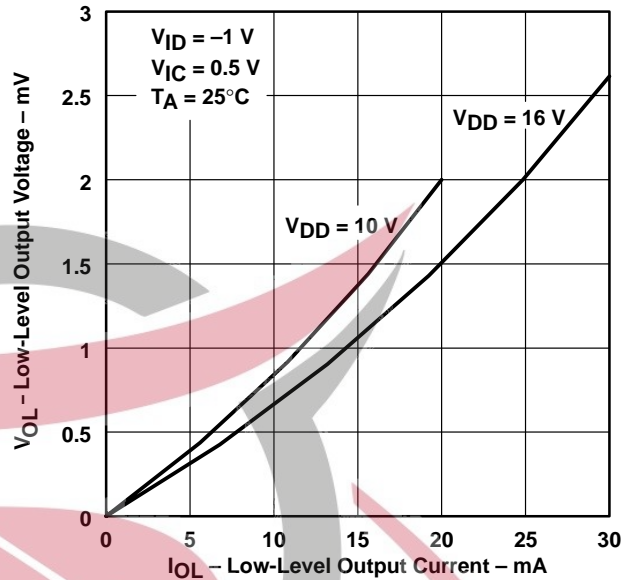

Figure 15

**LARGE-SIGNAL
 DIFFERENTIAL VOLTAGE AMPLIFICATION
 vs
 SUPPLY VOLTAGE**

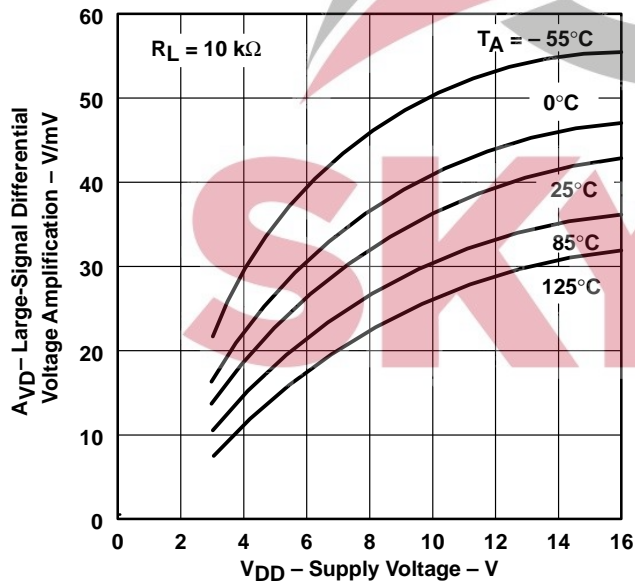

Figure 16

**LARGE-SIGNAL
 DIFFERENTIAL VOLTAGE AMPLIFICATION
 vs
 FREE-AIR TEMPERATURE**

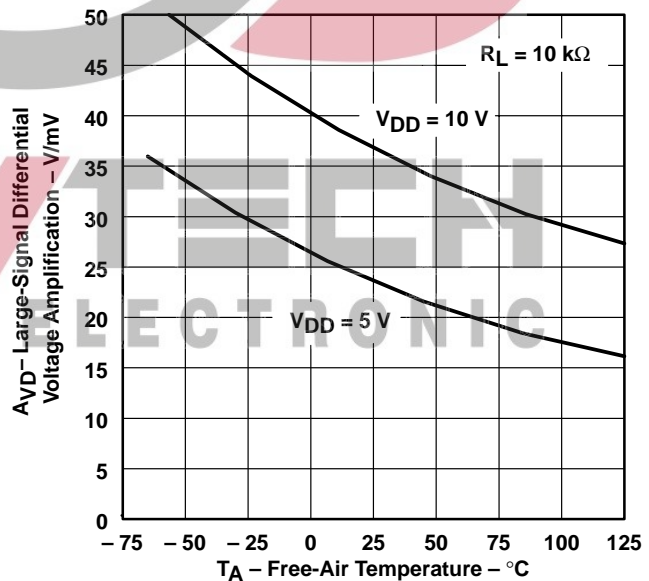
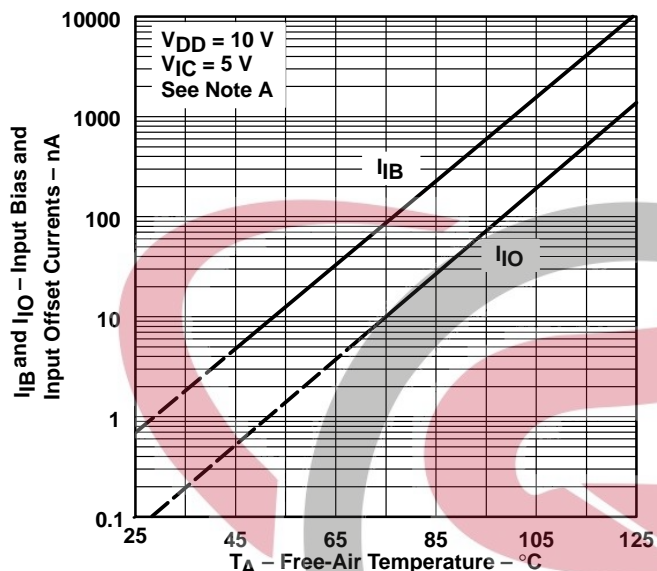

Figure 17

† Data at high and low temperatures are applicable only within the rated operating free-air temperature ranges of the various devices.

TYPICAL CHARACTERISTICS (HIGH-BIAS MODE)†

INPUT BIAS CURRENT AND INPUT OFFSET CURRENT
 vs
 FREE-AIR TEMPERATURE



NOTE A: The typical values of input bias current and input offset current below 5 pA were determined mathematically.

Figure 18

COMMON-MODE INPUT VOLTAGE (POSITIVE LIMIT)
 vs
 SUPPLY VOLTAGE

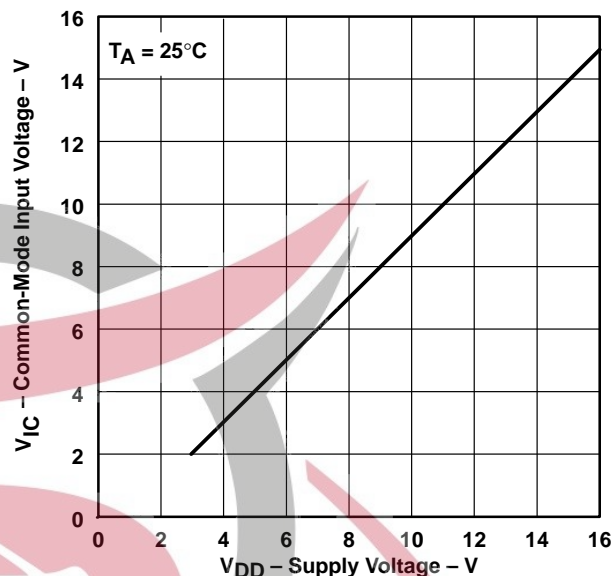

Figure 19

SUPPLY CURRENT
 vs
 SUPPLY VOLTAGE

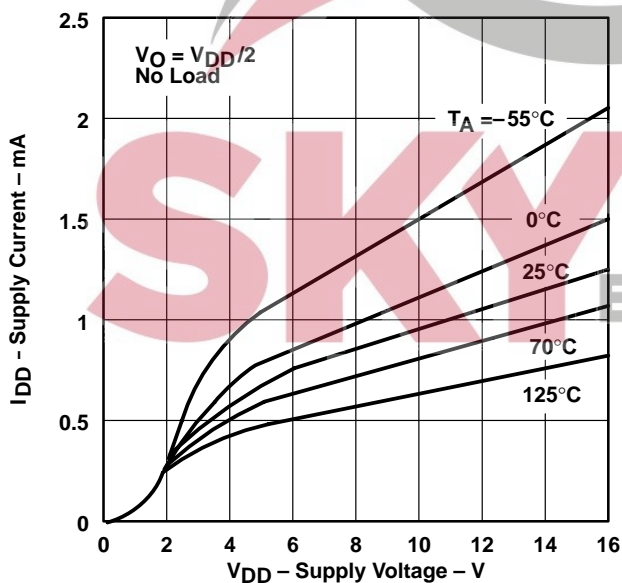

Figure 20

SUPPLY CURRENT
 vs
 FREE-AIR TEMPERATURE

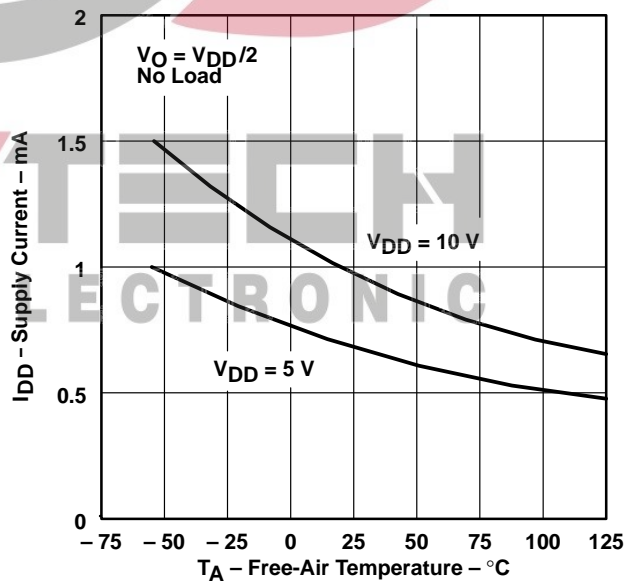

Figure 21

† Data at high and low temperatures are applicable only within the rated operating free-air temperature ranges of the various devices.

TYPICAL CHARACTERISTICS (HIGH-BIAS MODE)†

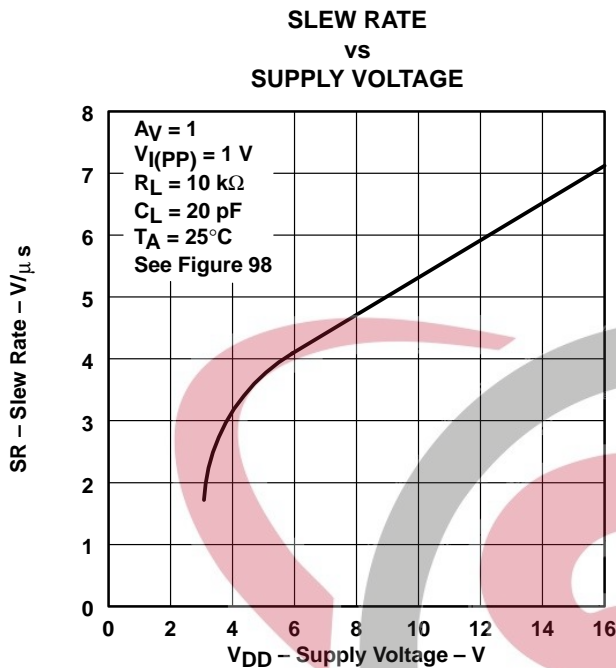

Figure 22

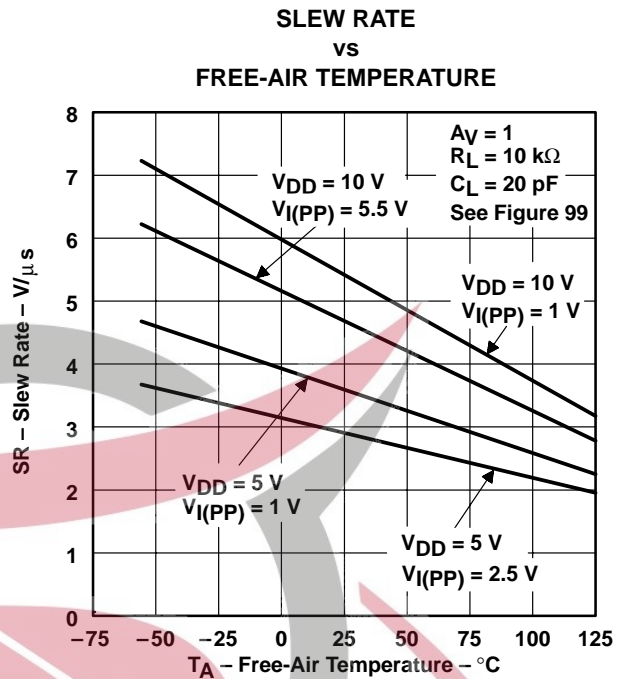

Figure 23

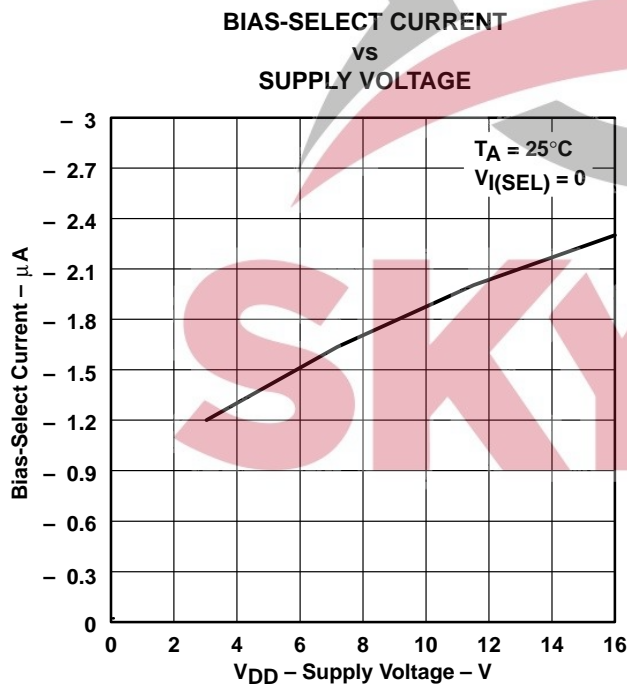

Figure 24

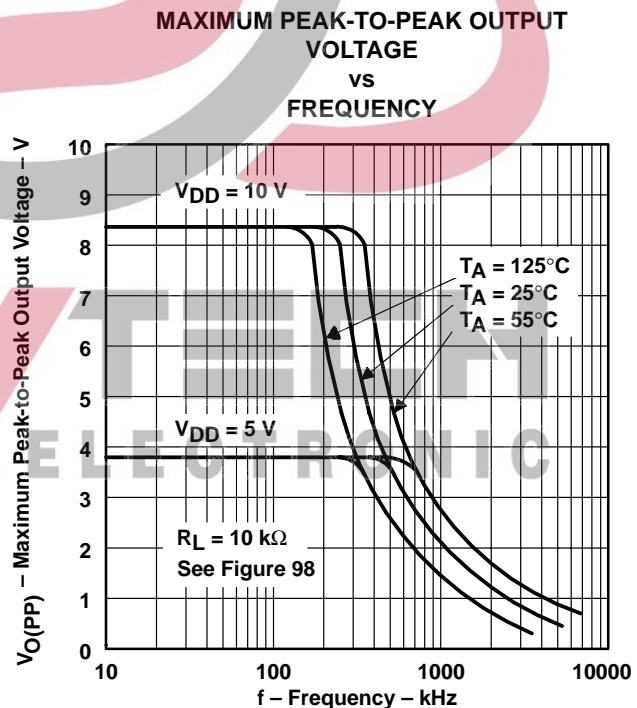

Figure 25

† Data at high and low temperatures are applicable only within the rated operating free-air temperature ranges of the various devices.

TYPICAL CHARACTERISTICS (HIGH-BIAS MODE)†

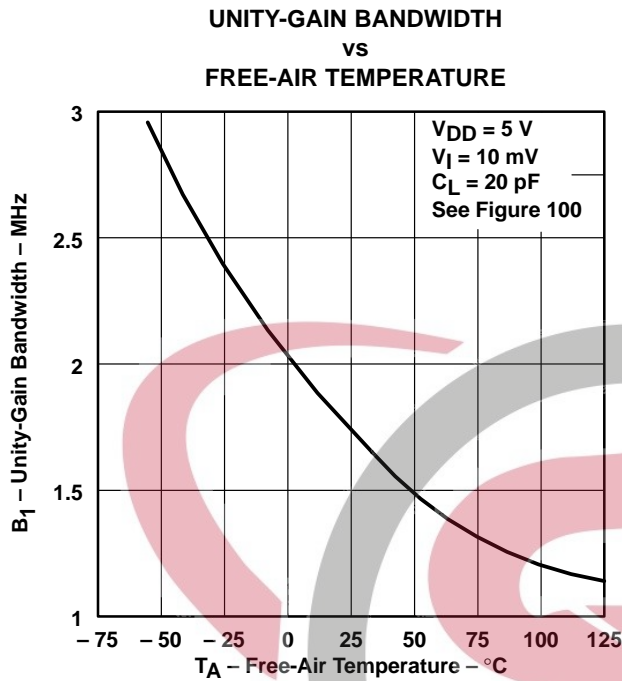

Figure 26

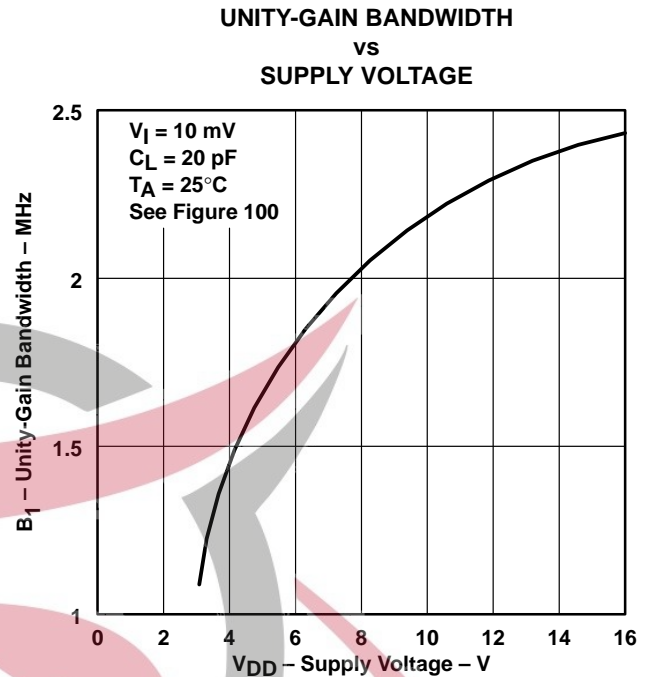

Figure 27

LARGE-SIGNAL DIFFERENTIAL VOLTAGE
 AMPLIFICATION AND PHASE SHIFT
 vs
 FREQUENCY

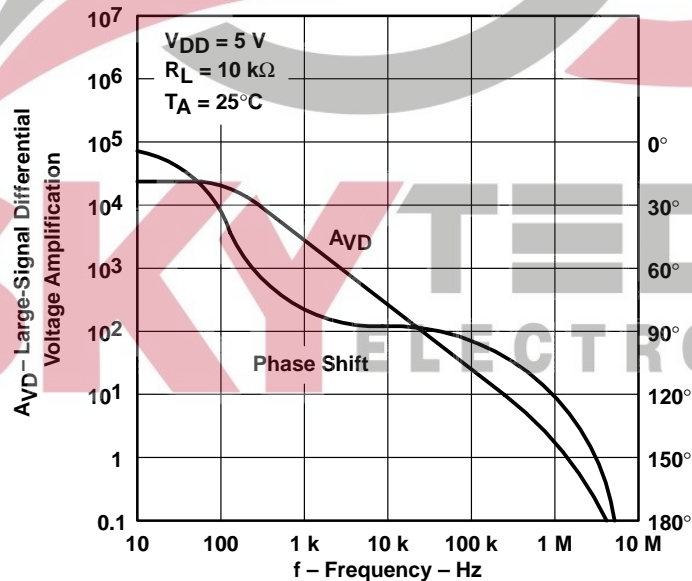

Figure 28

† Data at high and low temperatures are applicable only within the rated operating free-air temperature ranges of the various devices.

TYPICAL CHARACTERISTICS (HIGH-BIAS MODE)†

LARGE-SCALE DIFFERENTIAL VOLTAGE
 AMPLIFICATION AND PHASE SHIFT
 vs
 FREQUENCY

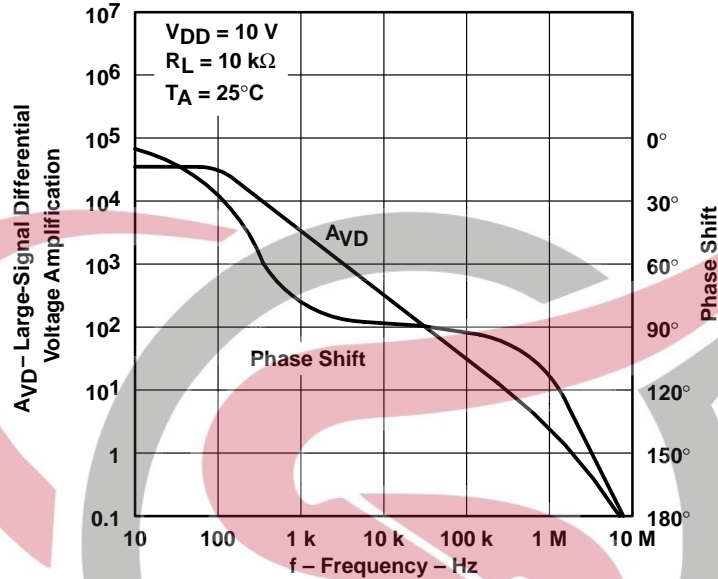

Figure 29

PHASE MARGIN
 vs
 SUPPLY VOLTAGE

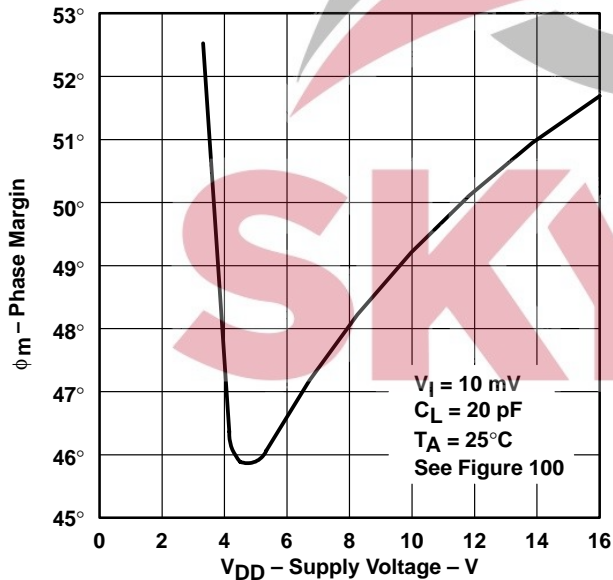

Figure 30

PHASE MARGIN
 vs
 FREE-AIR TEMPERATURE

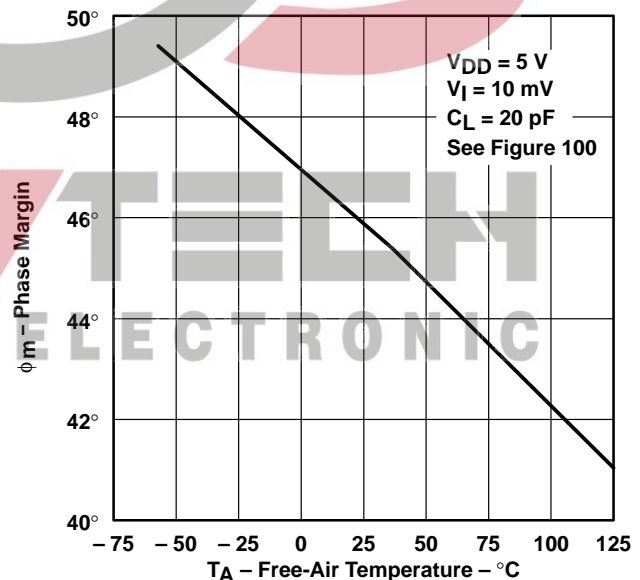
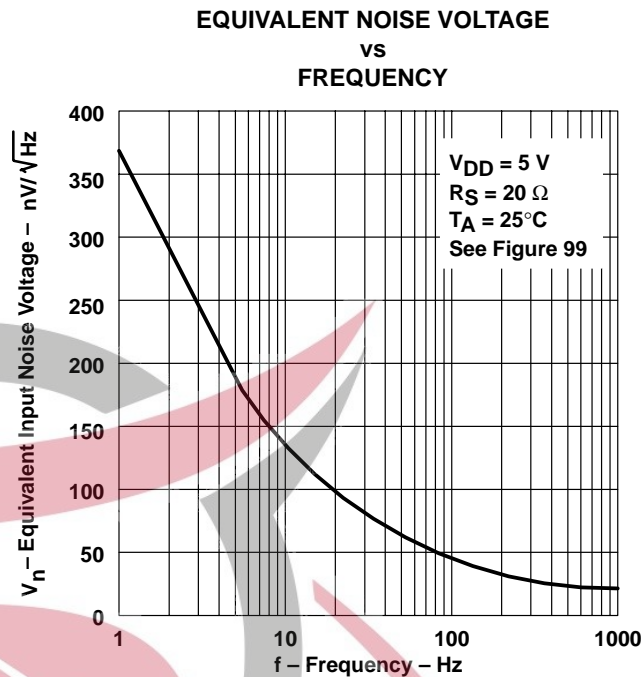
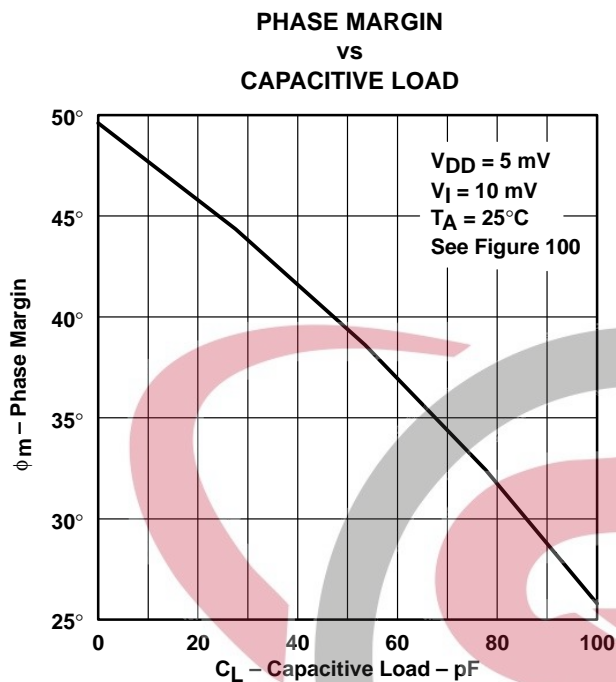

Figure 31

† Data at high and low temperatures are applicable only within the rated operating free-air temperature ranges of the various devices.

TYPICAL CHARACTERISTICS (HIGH-BIAS MODE)†



† Data at high and low temperatures are applicable only within the rated operating free-air temperature ranges of the various devices.



TLC271, TLC271A, TLC271B
LinCMOS™ PROGRAMMABLE LOW-POWER
OPERATIONAL AMPLIFIERS

SLOS090D – NOVEMBER 1987 – REVISED MARCH 2001

MEDIUM-BIAS MODE

electrical characteristics at specified free-air temperature (unless otherwise noted)

PARAMETER	TEST CONDITIONS	T _A †	TLC271C, TLC271AC, TLC271BC						UNIT
			V _{DD} = 5 V			V _{DD} = 10 V			
			MIN	TYP	MAX	MIN	TYP	MAX	
V _{IO} Input offset voltage	TLC271C V _O = 1.4 V, V _{IC} = 0 R _S = 50 Ω, R _I = 100 kΩ	25°C	1.1		10	1.1		10	mV
		Full range			12			12	
		25°C	0.9		5	0.9		5	
		Full range			6.5			6.5	
		25°C	0.25		2	0.26		2	
		Full range			3			3	
α _{VIO} Average temperature coefficient of input offset voltage		25°C to 70°C	1.7			2.1		μV/°C	
I _{IO} Input offset current (see Note 4)	V _O = V _{DD} /2, V _{IC} = V _{DD} /2	25°C	0.1	60	0.1	60			pA
		70°C	7	300	7	300			
I _{IB} Input bias current (see Note 4)	V _O = V _{DD} /2, V _{IC} = V _{DD} /2	25°C	0.6	60	0.7	60			pA
		70°C	40	600	50	600			
V _{ICR} Common-mode input voltage range (see Note 5)		25°C	-0.2 to 4	-0.3 to 4.2	-0.2 to 9	-0.3 to 9.2			V
		Full range	-0.2 to 3.5		-0.2 to 8.5				V
V _{OH} High-level output voltage	V _{ID} = 100 mV, R _L = 100 kΩ	25°C	3.2	3.9	8	8.7			V
		0°C	3	3.9	7.8	8.7			
		70°C	3	4	7.8	8.7			
V _{OL} Low-level output voltage	V _{ID} = -100 mV, I _{OL} = 0	25°C	0	50	0	50			mV
		0°C	0	50	0	50			
		70°C	0	50	0	50			
A _{VD} Large-signal differential voltage amplification	R _L = 100 kΩ, See Note 6	25°C	25	170	25	275			V/mV
		0°C	15	200	15	320			
		70°C	15	140	15	230			
CMRR Common-mode rejection ratio	V _{IC} = V _{ICRmin}	25°C	65	91	65	94			dB
		0°C	60	91	60	94			
		70°C	60	92	60	94			
k _{SVR} Supply-voltage rejection ratio (ΔV _{DD} /ΔV _{IO})	V _{DD} = 5 V to 10 V V _O = 1.4 V	25°C	70	93	70	93			dB
		0°C	60	92	60	92			
		70°C	60	94	60	94			
I _{I(SEL)} Input current (BIAS SELECT)	V _{I(SEL)} = V _{DD} /2	25°C	-130		-160				nA
I _{DD} Supply current	V _O = V _{DD} /2, V _{IC} = V _{DD} /2, No load	25°C	105	280	143	300			μA
		0°C	125	320	173	400			
		70°C	85	220	110	280			

† Full range is 0°C to 70°C.

- NOTES: 4. The typical values of input bias current and input offset current below 5 pA were determined mathematically.
5. This range also applies to each input individually.
6. At V_{DD} = 5 V, V_O = 0.25 V to 2 V; at V_{DD} = 10 V, V_O = 1 V to 6 V.



MEDIUM-BIAS MODE

electrical characteristics at specified free-air temperature (unless otherwise noted)

PARAMETER		TEST CONDITIONS	T _A †	TLC271I, TLC271AI, TLC271BI						UNIT
				V _{DD} = 5 V			V _{DD} = 10 V			
				MIN	TYP	MAX	MIN	TYP	MAX	
V _{IO}	Input offset voltage	V _O = 1.4 V, V _{IC} = 0 V, R _S = 50 Ω, R _L = 100 kΩ	25°C	1.1		10	1.1		10	mV
			Full range			13			13	
			25°C	0.9		5	0.9		5	
			Full range			7			7	
			25°C	0.25		2	0.26		2	
			Full range			3.5			3.5	
α _{VIO}	Average temperature coefficient of input offset voltage		25°C to 85°C	1.7			2.1		μV/°C	
I _{IO}	Input offset current (see Note 4)	V _O = V _{DD} /2, V _{IC} = V _{DD} /2	25°C	0.1		60	0.1		60	pA
			85°C	24		1000	26		1000	
I _{IB}	Input bias current (see Note 4)	V _O = V _{DD} /2, V _{IC} = V _{DD} /2	25°C	0.6		60	0.7		60	pA
			85°C	200		2000	220		2000	
V _{ICR}	Common-mode input voltage range (see Note 5)		25°C	-0.2 to 4	-0.3 to 4.2		-0.2 to 9	-0.3 to 9.2	V	
			Full range	-0.2 to 3.5			-0.2 to 8.5		V	
V _{OH}	High-level output voltage	V _{ID} = 100 mV, R _L = 100 kΩ	25°C	3.2		3.9	8		8.7	V
			-40°C	3		3.9	7.8		8.7	
			85°C	3		4	7.8		8.7	
V _{OL}	Low-level output voltage	V _{ID} = -100 mV, I _{OL} = 0	25°C	0		50	0		50	mV
			-40°C	0		50	0		50	
			85°C	0		50	0		50	
A _{VD}	Large-signal differential voltage amplification	R _L = 100 kΩ, See Note 6	25°C	25		170	25		275	V/mV
			-40°C	15		270	15		390	
			85°C	15		130	15		220	
CMRR	Common-mode rejection ratio	V _{IC} = V _{ICRmin}	25°C	65		91	65		94	dB
			-40°C	60		90	60		93	
			85°C	60		90	60		94	
k _{SVR}	Supply-voltage rejection ratio (ΔV _{DD} /ΔV _{IO})	V _{DD} = 5 V to 10 V V _O = 1.4 V	25°C	70		93	70		93	dB
			-40°C	60		91	60		91	
			85°C	60		94	60		94	
I _{I(SEL)}	Input current (BIAS SELECT)	V _{I(SEL)} = V _{DD} /2	25°C	-130			-160		nA	
I _{DD}	Supply current	V _O = V _{DD} /2, V _{IC} = V _{DD} /2, No load	25°C	105		280	143		300	μA
			-40°C	158		400	225		450	
			85°C	80		200	103		260	

† Full range is -40°C to 85°C.

- NOTES:
4. The typical values of input bias current and input offset current below 5 pA were determined mathematically.
 5. This range also applies to each input individually.
 6. At V_{DD} = 5 V, V_O = 0.25 V to 2 V; at V_{DD} = 10 V, V_O = 1 V to 6 V.

TLC271, TLC271A, TLC271B
LinCMOS™ PROGRAMMABLE LOW-POWER
OPERATIONAL AMPLIFIERS

SLOS090D – NOVEMBER 1987 – REVISED MARCH 2001

MEDIUM-BIAS MODE

electrical characteristics at specified free-air temperature (unless otherwise noted)

PARAMETER	TEST CONDITIONS	T _A †	TLC271M						UNIT
			V _{DD} = 5 V			V _{DD} = 10 V			
			MIN	TYP	MAX	MIN	TYP	MAX	
V _{IO} Input offset voltage	V _O = 1.4 V, V _{IC} = 0 V, R _S = 50 Ω, R _L = 100 kΩ	25°C		1.1	10		1.1	10	mV
		Full range				12		12	
α _{VIO} Average temperature coefficient of input offset voltage		25°C to 125°C		1.7			2.1		μV/°C
I _{IO} Input offset current (see Note 4)	V _O = V _{DD} /2, V _{IC} = V _{DD} /2	25°C		0.1	60		0.1	60	pA
		125°C		1.4	15		1.8	15	nA
I _{IB} Input bias current (see Note 4)	V _O = V _{DD} /2, V _{IC} = V _{DD} /2	25°C		0.6	60		0.7	60	pA
		125°C		9	35		10	35	nA
V _{ICR} Common-mode input voltage range (see Note 5)		25°C	0 to 4	-0.3 to 4.2		0 to 9	-0.3 to 9.2		V
		Full range	0 to 3.5			0 to 8.5			V
V _{OH} High-level output voltage	V _{ID} = 100 mV, R _L = 100 kΩ	25°C	3.2	3.9		8	8.7		V
		-55°C	3	3.9		7.8	8.6		
		125°C	3	4		7.8	8.6		
V _{OL} Low-level output voltage	V _{ID} = -100 mV, I _{OL} = 0	25°C		0	50		0	50	mV
		-55°C		0	50		0	50	
		125°C		0	50		0	50	
A _{VD} Large-signal differential voltage amplification	R _L = 10 kΩ See Note 6	25°C	25	170		25	275		V/mV
		-55°C	15	290		15	420		
		125°C	15	120		15	190		
CMRR Common-mode rejection ratio	V _{IC} = V _{ICRmin}	25°C	65	91		65	94		dB
		-55°C	60	89		60	93		
		125°C	60	91		60	93		
k _{SVR} Supply-voltage rejection ratio (ΔV _{DD} /ΔV _{IO})	V _{DD} = 5 V to 10 V V _O = 1.4 V	25°C	70	93		70	93		dB
		-55°C	60	91		60	91		
		125°C	60	94		60	94		
I _{I(SEL)} Input current (BIAS SELECT)	V _{I(SEL)} = V _{DD} /2	25°C		-130		-160		nA	
I _{DD} Supply current	V _O = V _{DD} /2, V _{IC} = V _{DD} /2, No load	25°C		105	280		143	300	μA
		-55°C		170	440		245	500	
		125°C		70	180		90	240	

† Full range is -55°C to 125°C.

NOTES: 4. The typical values of input bias current and input offset current below 5 pA were determined mathematically.

5. This range also applies to each input individually.

6. At V_{DD} = 5 V, V_O = 0.25 V to 2 V; at V_{DD} = 10 V, V_O = 1 V to 6 V.



MEDIUM-BIAS MODE

operating characteristics at specified free-air temperature, $V_{DD} = 5\text{ V}$

PARAMETER	TEST CONDITIONS	T_A	TLC271C, TLC271AC, TLC271BC			UNIT
			MIN	TYP	MAX	
SR Slew rate at unity gain	$R_L = 100\text{ k}\Omega$, $C_L = 20\text{ pF}$, See Figure 98	$V_{I(PP)} = 1\text{ V}$	25°C	0.43		V/ μ s
			0°C	0.46		
			70°C	0.36		
		$V_{I(PP)} = 2.5\text{ V}$	25°C	0.40		
			0°C	0.43		
			70°C	0.34		
V_n Equivalent input noise voltage	$f = 1\text{ kHz}$, See Figure 99	$R_S = 20\ \Omega$, 25°C	32		nV/ $\sqrt{\text{Hz}}$	
B_{OM} Maximum output-swing bandwidth	$V_O = V_{OH}$, $R_L = 100\text{ k}\Omega$, See Figure 98	$C_L = 20\text{ pF}$, See Figure 98	25°C	55		kHz
			0°C	60		
			70°C	50		
B_1 Unity-gain bandwidth	$V_I = 10\text{ mV}$, See Figure 100	$C_L = 20\text{ pF}$,	25°C	525		kHz
			0°C	600		
			70°C	400		
ϕ_m Phase margin	$V_I = 10\text{ mV}$, $C_L = 20\text{ pF}$,	$f = B_1$, See Figure 100	25°C	40°		
			0°C	41°		
			70°C	39°		

operating characteristics at specified free-air temperature, $V_{DD} = 10\text{ V}$

PARAMETER	TEST CONDITIONS	T_A	TLC271C, TLC271AC, TLC271BC			UNIT
			MIN	TYP	MAX	
SR Slew rate at unity gain	$R_L = 100\text{ k}\Omega$, $C_L = 20\text{ pF}$, See Figure 98	$V_{I(PP)} = 1\text{ V}$	25°C	0.62		V/ μ s
			0°C	0.67		
			70°C	0.51		
		$V_{I(PP)} = 5.5\text{ V}$	25°C	0.56		
			0°C	0.61		
			70°C	0.46		
V_n Equivalent input noise voltage	$f = 1\text{ kHz}$, See Figure 99	$R_S = 20\ \Omega$, 25°C	32		nV/ $\sqrt{\text{Hz}}$	
B_{OM} Maximum output-swing bandwidth	$V_O = V_{OH}$, $R_L = 100\text{ k}\Omega$, See Figure 98	$C_L = 20\text{ pF}$, See Figure 98	25°C	35		kHz
			0°C	40		
			70°C	30		
B_1 Unity-gain bandwidth	$V_I = 10\text{ mV}$, See Figure 100	$C_L = 20\text{ pF}$,	25°C	635		kHz
			0°C	710		
			70°C	510		
ϕ_m Phase margin	$V_I = 10\text{ mV}$, $C_L = 20\text{ pF}$,	$f = B_1$, See Figure 100	25°C	43°		
			0°C	44°		
			70°C	42°		

TLC271, TLC271A, TLC271B
LinCMOS™ PROGRAMMABLE LOW-POWER
OPERATIONAL AMPLIFIERS

SLOS090D – NOVEMBER 1987 – REVISED MARCH 2001

MEDIUM-BIAS MODE

operating characteristics at specified free-air temperature, $V_{DD} = 5\text{ V}$

PARAMETER	TEST CONDITIONS	T_A	TLC271I, TLC271AI, TLC271BI			UNIT
			MIN	TYP	MAX	
SR Slew rate at unity gain	$R_L = 100\text{ k}\Omega$, $C_L = 20\text{ pF}$, See Figure 98	$V_{I(PP)} = 1\text{ V}$	25°C	0.43		V/ μ s
			-40°C	0.51		
			85°C	0.35		
		$V_{I(PP)} = 2.5\text{ V}$	25°C	0.40		
			-40°C	0.48		
			85°C	0.32		
V_n Equivalent input noise voltage	$f = 1\text{ kHz}$, See Figure 99	$R_S = 20\ \Omega$, 25°C	32		nV/ $\sqrt{\text{Hz}}$	
B_{OM} Maximum output-swing bandwidth	$V_O = V_{OH}$, $R_L = 100\text{ k}\Omega$, $C_L = 20\text{ pF}$, See Figure 98	25°C	55		kHz	
		-40°C	75			
		85°C	45			
B_1 Unity-gain bandwidth	$V_I = 10\text{ mV}$, See Figure 100	$C_L = 20\text{ pF}$, 25°C	525		MHz	
		-40°C	770			
		85°C	370			
ϕ_m Phase margin	$V_I = 10\text{ mV}$, $C_L = 20\text{ pF}$, $f = B_1$, See Figure 100	25°C	40°			
		-40°C	43°			
		85°C	38°			

operating characteristics at specified free-air temperature, $V_{DD} = 10\text{ V}$

PARAMETER	TEST CONDITIONS	T_A	TLC271I, TLC271AI, TLC271BI			UNIT
			MIN	TYP	MAX	
SR Slew rate at unity gain	$R_L = 100\text{ k}\Omega$, $C_L = 20\text{ pF}$, See Figure 98	$V_{I(PP)} = 1\text{ V}$	25°C	0.62		V/ μ s
			-40°C	0.77		
			85°C	0.47		
		$V_{I(PP)} = 5.5\text{ V}$	25°C	0.56		
			-40°C	0.70		
			85°C	0.44		
V_n Equivalent input noise voltage	$f = 1\text{ kHz}$, See Figure 99	$R_S = 20\ \Omega$, 25°C	32		nV/ $\sqrt{\text{Hz}}$	
B_{OM} Maximum output-swing bandwidth	$V_O = V_{OH,3}$, $R_L = 100\text{ k}\Omega$, $C_L = 20\text{ pF}$, See Figure 98	25°C	35		kHz	
		-40°C	45			
		85°C	25			
B_1 Unity-gain bandwidth	$V_I = 10\text{ mV}$, See Figure 100	$C_L = 20\text{ pF}$, 25°C	635		kHz	
		-40°C	880			
		85°C	480			
ϕ_m Phase margin	$V_I = 10\text{ mV}$, $C_L = 20\text{ pF}$, $f = B_1$, See Figure 100	25°C	43°			
		-40°C	46°			
		85°C	41°			



MEDIUM-BIAS MODE

operating characteristics at specified free-air temperature, $V_{DD} = 5\text{ V}$

PARAMETER	TEST CONDITIONS	T_A	TLC271M			UNIT
			MIN	TYP	MAX	
SR Slew rate at unity gain	$R_L = 100\text{ k}\Omega$, $C_L = 20\text{ pF}$, See Figure 98	$V_I(\text{PP}) = 1\text{ V}$	25°C	0.43		V/ μs
			-55°C	0.54		
			125°C	0.29		
		$V_I(\text{PP}) = 2.5\text{ V}$	25°C	0.40		
			-55°C	0.50		
			125°C	0.28		
V_n Equivalent input noise voltage	$f = 1\text{ kHz}$, See Figure 99	$R_S = 20\ \Omega$, 25°C	32		nV/ $\sqrt{\text{Hz}}$	
B_{OM} Maximum output-swing bandwidth	$V_O = V_{\text{OH}}$, $R_L = 100\text{ k}\Omega$, See Figure 98	$C_L = 20\text{ pF}$, See Figure 98	25°C	55		kHz
			-55°C	80		
			125°C	40		
B_1 Unity-gain bandwidth	$V_I = 10\text{ mV}$, See Figure 100	$C_L = 20\text{ pF}$	25°C	525		kHz
			-55°C	850		
			125°C	330		
ϕ_m Phase margin	$V_I = 10\text{ mV}$, $C_L = 20\text{ pF}$,	$f = B_1$, See Figure 100	25°C	40°		
			-55°C	43°		
			125°C	36°		

operating characteristics at specified free-air temperature, $V_{DD} = 10\text{ V}$

PARAMETER	TEST CONDITIONS	T_A	TLC271M			UNIT
			MIN	TYP	MAX	
SR Slew rate at unity gain	$R_L = 100\text{ k}\Omega$, $C_L = 20\text{ pF}$, See Figure 98	$V_I(\text{PP}) = 1\text{ V}$	25°C	0.62		V/ μs
			-55°C	0.81		
			125°C	0.38		
		$V_I(\text{PP}) = 5.5\text{ V}$	25°C	0.56		
			-55°C	0.73		
			125°C	0.35		
V_n Equivalent input noise voltage	$f = 1\text{ kHz}$, See Figure 99	$R_S = 20\ \Omega$, 25°C	32		nV/ $\sqrt{\text{Hz}}$	
B_{OM} Maximum output-swing bandwidth	$V_O = V_{\text{OH}}$, $R_L = 100\text{ k}\Omega$, See Figure 98	$C_L = 20\text{ pF}$, See Figure 98	25°C	35		kHz
			-55°C	50		
			125°C	20		
B_1 Unity-gain bandwidth	$V_I = 10\text{ mV}$, See Figure 100	$C_L = 20\text{ pF}$	25°C	635		kHz
			-55°C	960		
			125°C	440		
ϕ_m Phase margin	$V_I = 10\text{ mV}$, $C_L = 20\text{ pF}$,	$f = B_1$, See Figure 100	25°C	43°		
			-55°C	47°		
			125°C	39°		

TLC271, TLC271A, TLC271B
LinCMOS™ PROGRAMMABLE LOW-POWER
OPERATIONAL AMPLIFIERS

SLOS090D – NOVEMBER 1987 – REVISED MARCH 2001

TYPICAL CHARACTERISTICS (MEDIUM-BIAS MODE)

Table of Graphs

		FIGURE	
V_{IO}	Input offset voltage	Distribution	34, 35
α_{VIO}	Temperature coefficient	Distribution	36, 37
V_{OH}	High-level output voltage	vs High-level output current	38, 39
		vs Supply voltage	40
		vs Free-air temperature	41
V_{OL}	Low-level output voltage	vs Common-mode input voltage	42, 43
		vs Differential input voltage	44
		vs Free-air temperature	45
		vs Low-level output current	46, 47
A_{VD}	Large-signal differential voltage amplification	vs Supply voltage	48
		vs Free-air temperature	49
		vs Frequency	60, 61
I_{IB}	Input bias current	vs Free-air temperature	50
I_{IO}	Input offset current	vs Free-air temperature	50
V_I	Maximum Input voltage	vs Supply voltage	51
I_{DD}	Supply current	vs Supply voltage	52
		vs Free-air temperature	53
SR	Slew rate	vs Supply voltage	54
		vs Free-air temperature	55
	Bias-select current	vs Supply voltage	56
$V_{O(PP)}$	Maximum peak-to-peak output voltage	vs Frequency	57
B_1	Unity-gain bandwidth	vs Free-air temperature	58
		vs Supply voltage	59
ϕ_m	Phase margin	vs Supply voltage	62
		vs Free-air temperature	63
		vs Capacitive load	64
V_n	Equivalent input noise voltage	vs Frequency	65
		Phase shift	60, 61



TYPICAL CHARACTERISTICS (MEDIUM-BIAS MODE)†

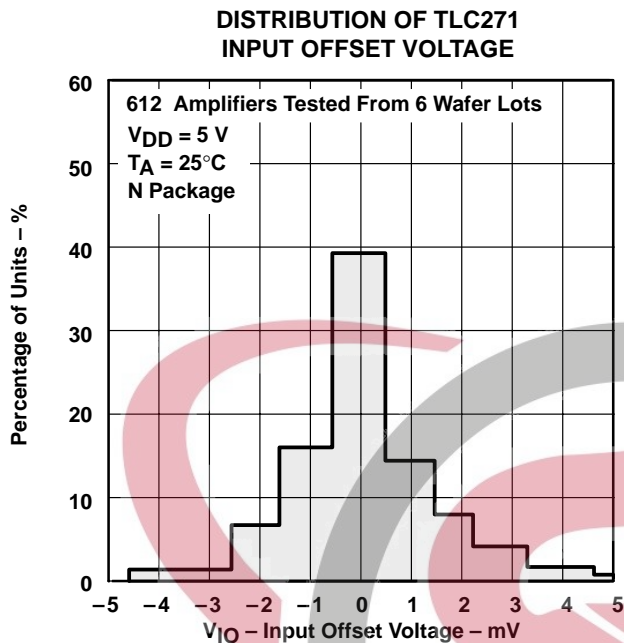

Figure 34

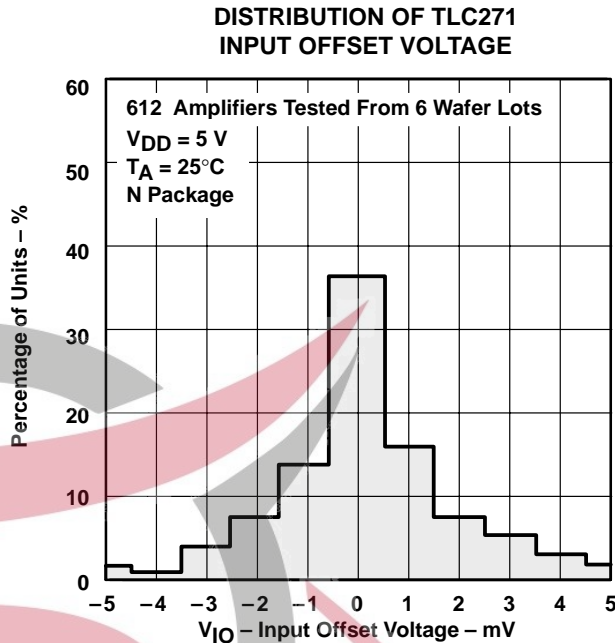

Figure 35

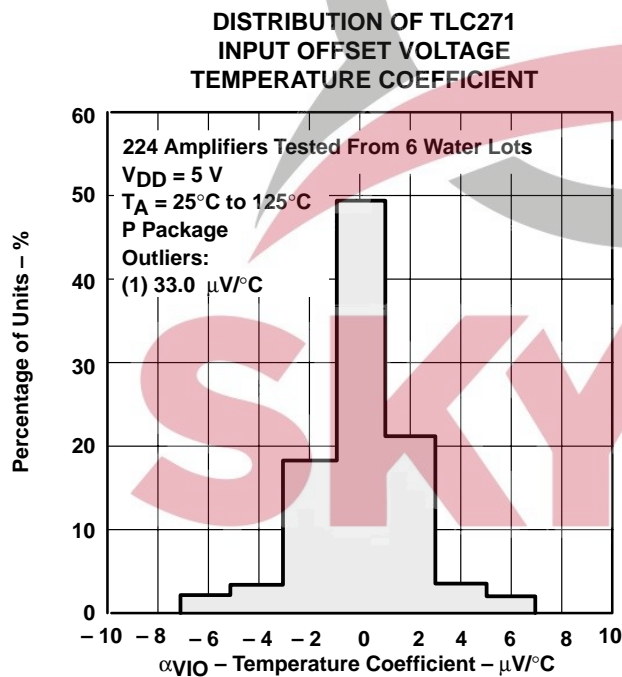

Figure 36

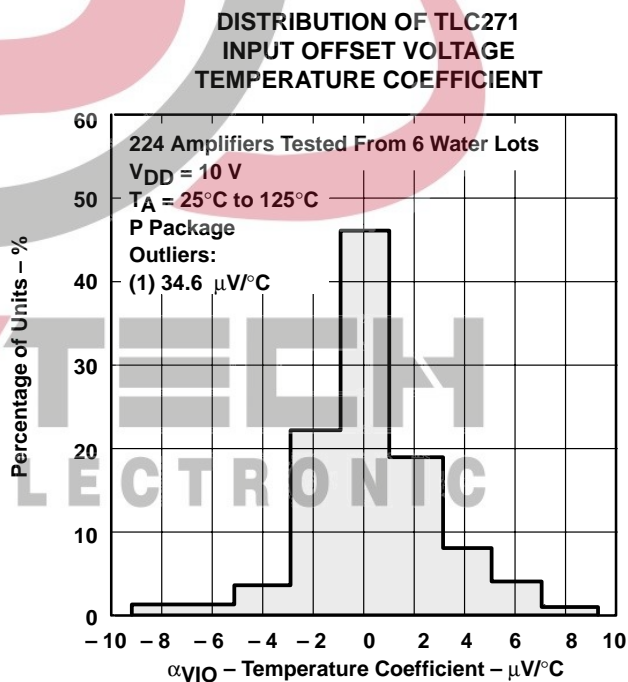

Figure 37

† Data at high and low temperatures are applicable only within the rated operating free-air temperature ranges of the various devices.

TYPICAL CHARACTERISTICS (MEDIUM-BIAS MODE)†

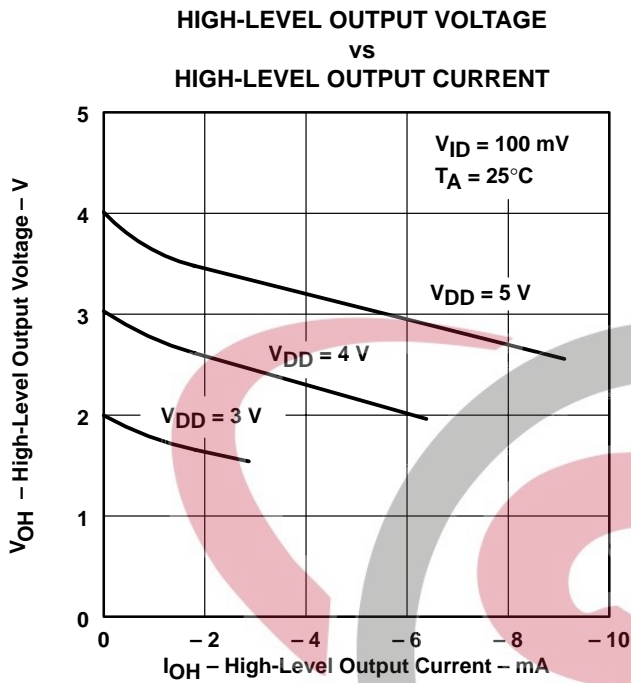

Figure 38

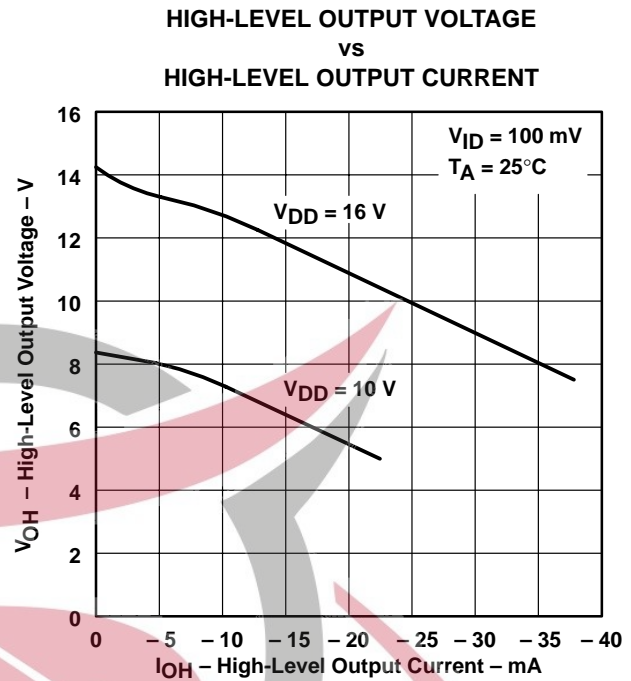

Figure 39

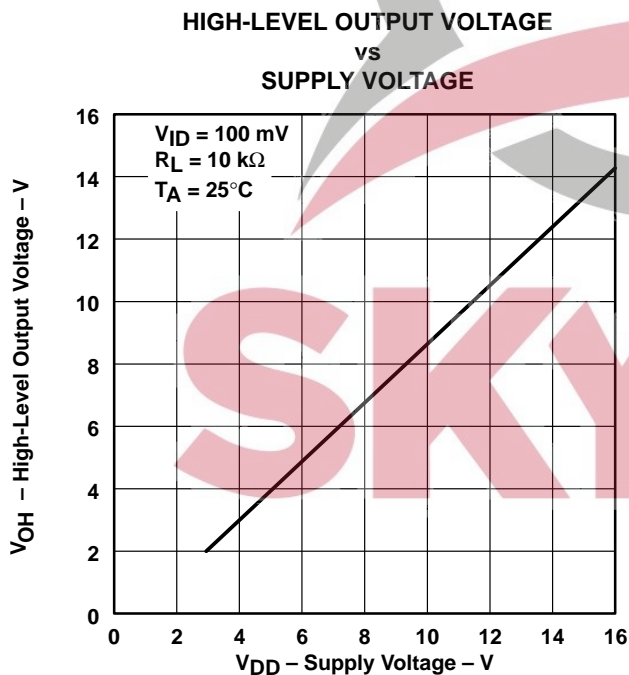

Figure 40

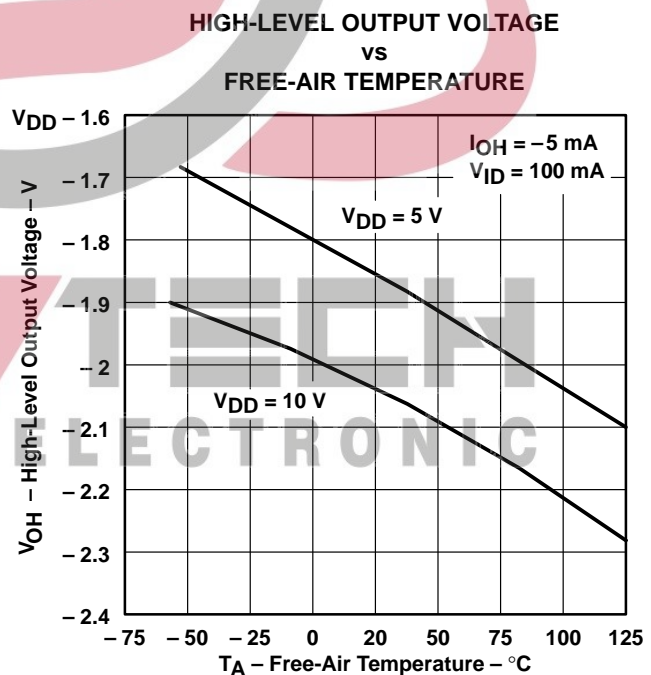

Figure 41

† Data at high and low temperatures are applicable only within the rated operating free-air temperature ranges of the various devices.

TYPICAL CHARACTERISTICS (MEDIUM-BIAS MODE)†

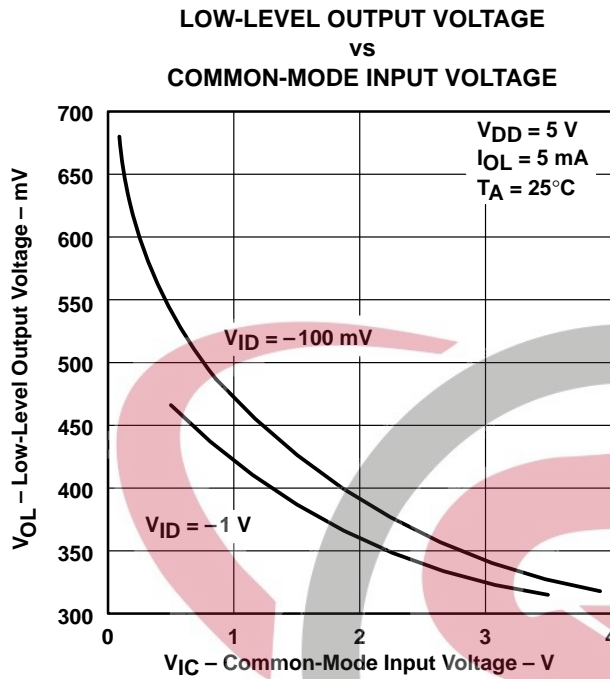

Figure 42

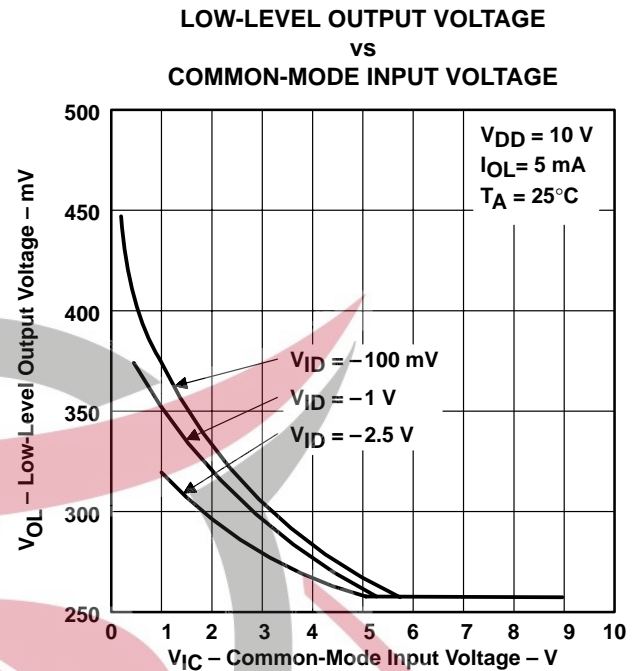

Figure 43

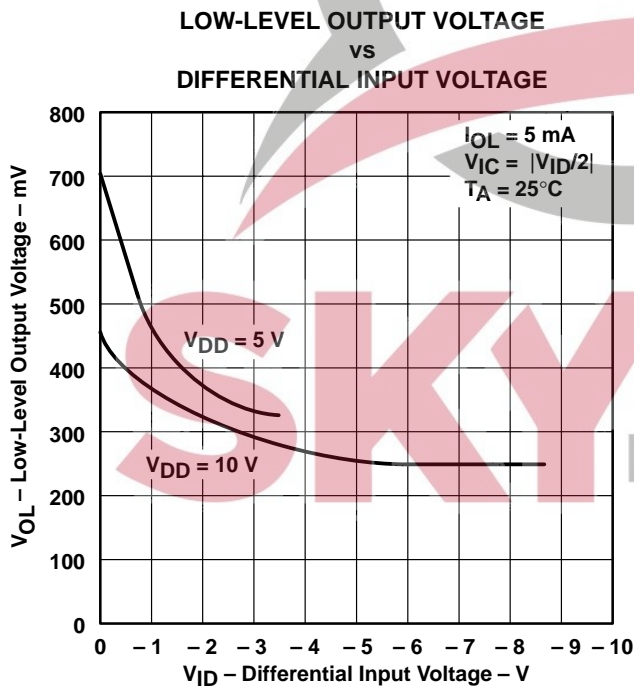

Figure 44

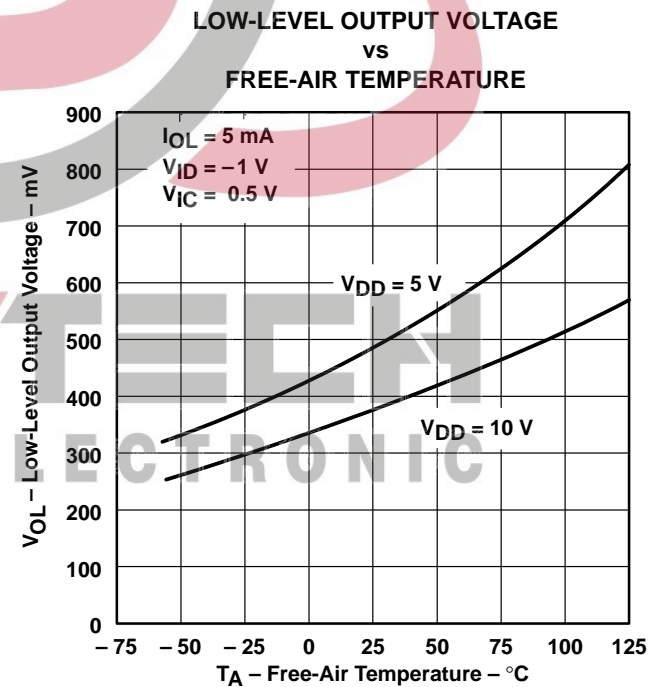

Figure 45

† Data at high and low temperatures are applicable only within the rated operating free-air temperature ranges of the various devices.

TYPICAL CHARACTERISTICS (MEDIUM-BIAS MODE)†

**LOW-LEVEL OUTPUT VOLTAGE
 vs
 LOW-LEVEL OUTPUT CURRENT**

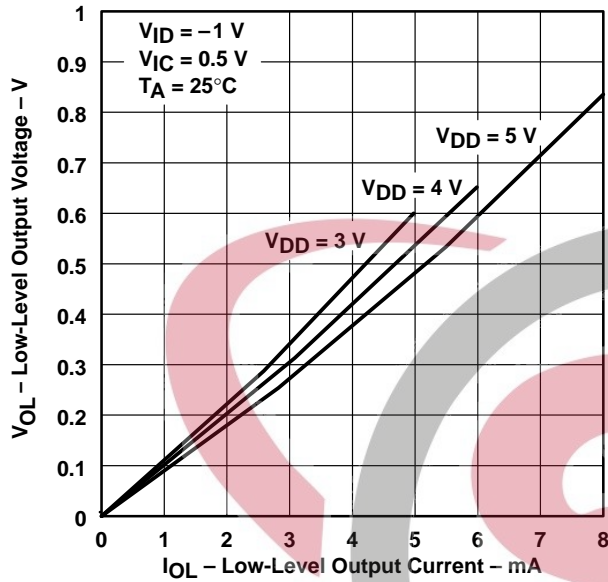

Figure 46

**LOW-LEVEL OUTPUT VOLTAGE
 vs
 LOW-LEVEL OUTPUT CURRENT**

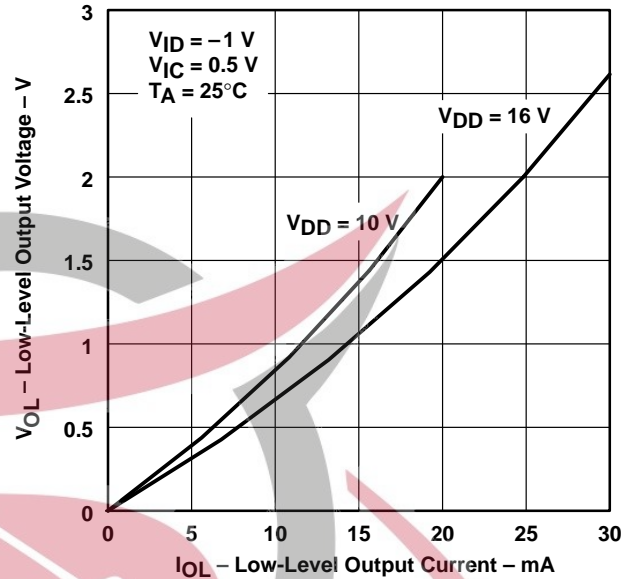

Figure 47

**LARGE-SIGNAL
 DIFFERENTIAL VOLTAGE AMPLIFICATION
 vs
 SUPPLY VOLTAGE**

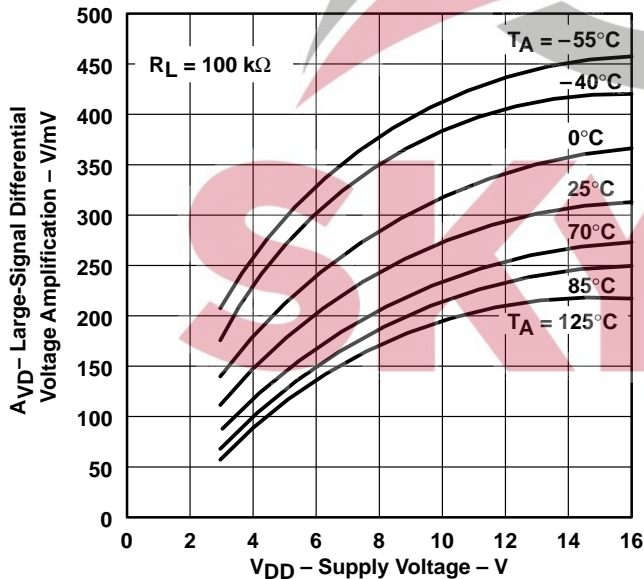

Figure 48

**LARGE-SIGNAL
 DIFFERENTIAL VOLTAGE AMPLIFICATION
 vs
 FREE-AIR TEMPERATURE**

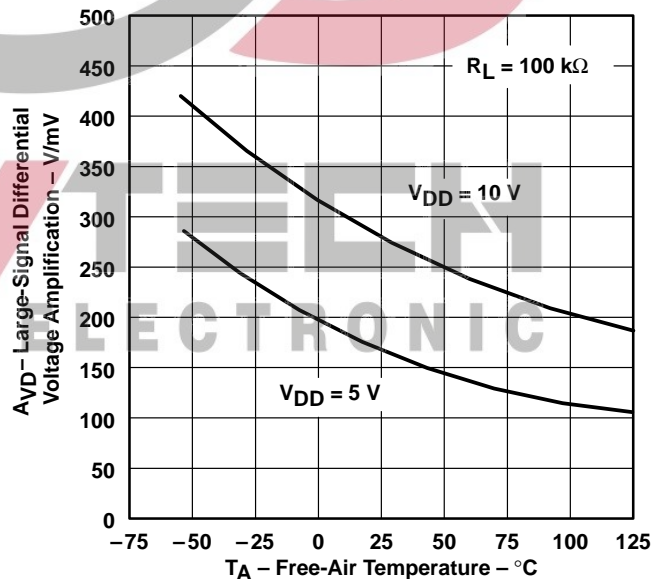

Figure 49

† Data at high and low temperatures are applicable only within the rated operating free-air temperature ranges of the various devices.

TYPICAL CHARACTERISTICS (MEDIUM-BIAS MODE)†

INPUT BIAS CURRENT AND INPUT OFFSET CURRENT
 vs
 FREE-AIR TEMPERATURE

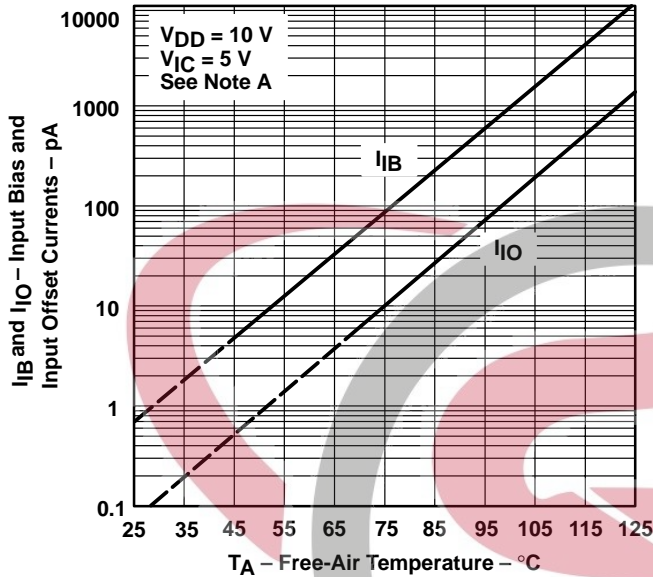

Figure 50

MAXIMUM INPUT VOLTAGE
 vs
 SUPPLY VOLTAGE

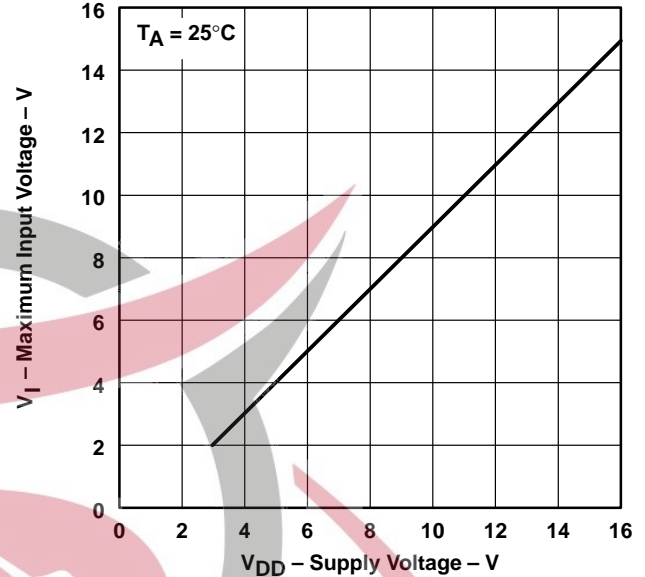

Figure 51

NOTE A: The typical values of input bias current and input offset current below 5 pA were determined mathematically.

SUPPLY CURRENT
 vs
 SUPPLY VOLTAGE

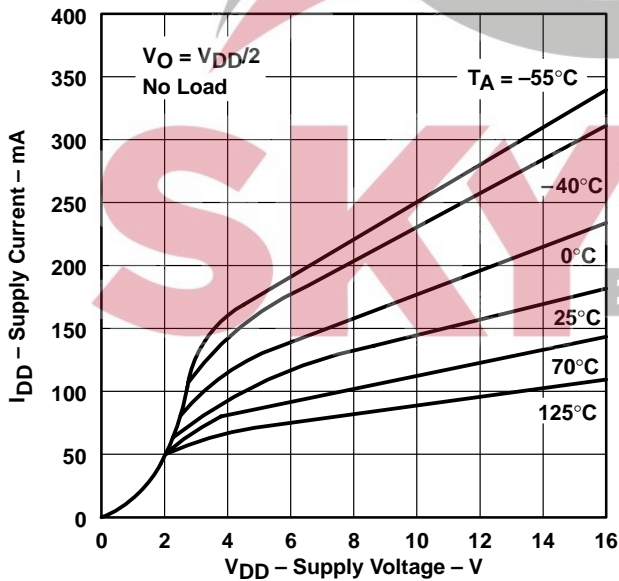

Figure 52

SUPPLY CURRENT
 vs
 FREE-AIR TEMPERATURE

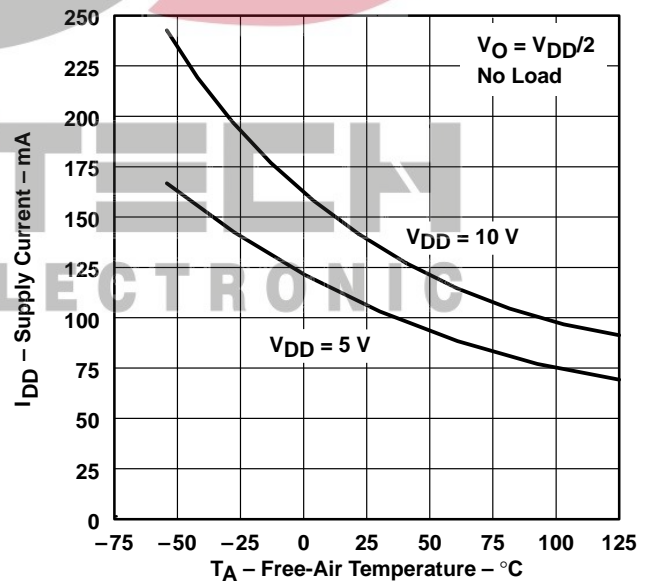

Figure 53

† Data at high and low temperatures are applicable only within the rated operating free-air temperature ranges of the various devices.

TYPICAL CHARACTERISTICS (MEDIUM-BIAS MODE)†

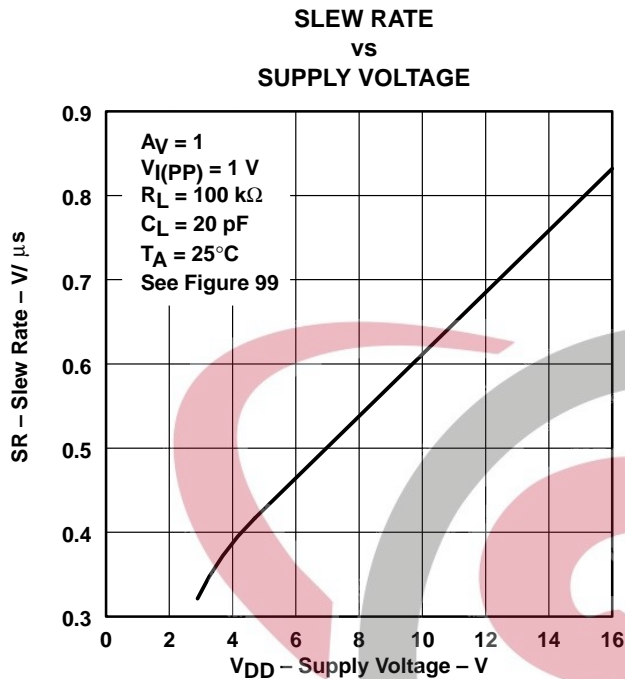

Figure 54

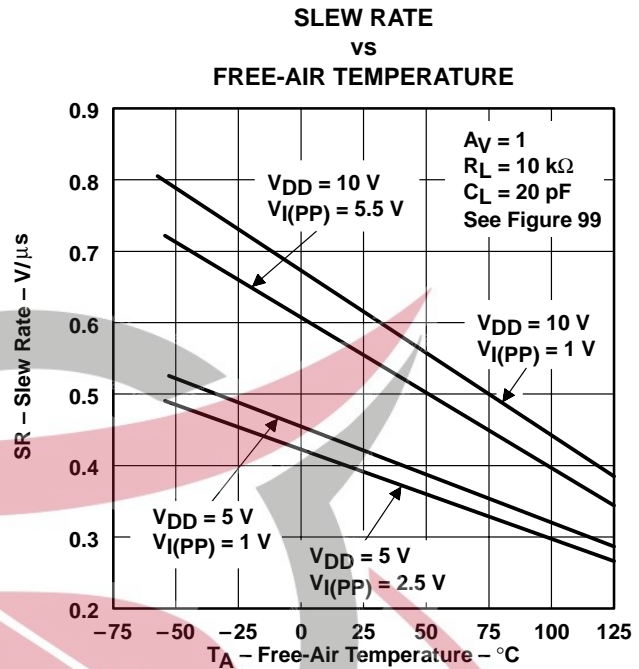

Figure 55

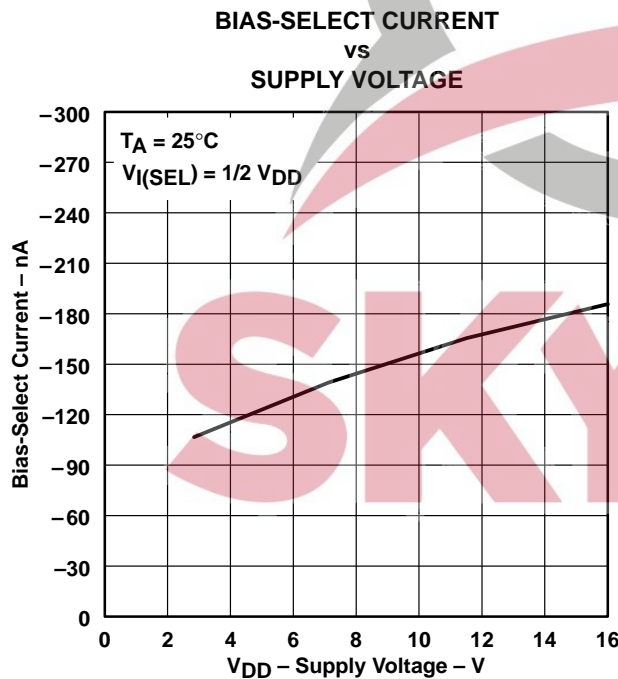

Figure 56

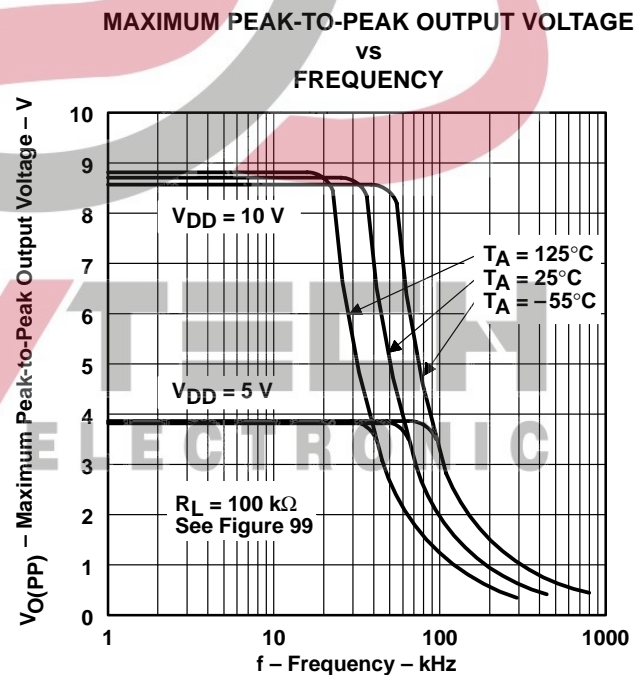

Figure 57

† Data at high and low temperatures are applicable only within the rated operating free-air temperature ranges of the various devices.

TYPICAL CHARACTERISTICS (MEDIUM-BIAS MODE)†

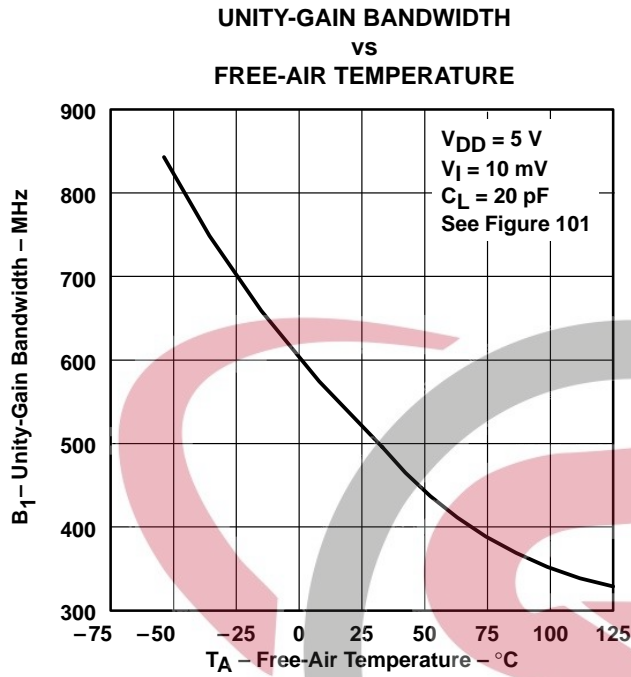

Figure 58

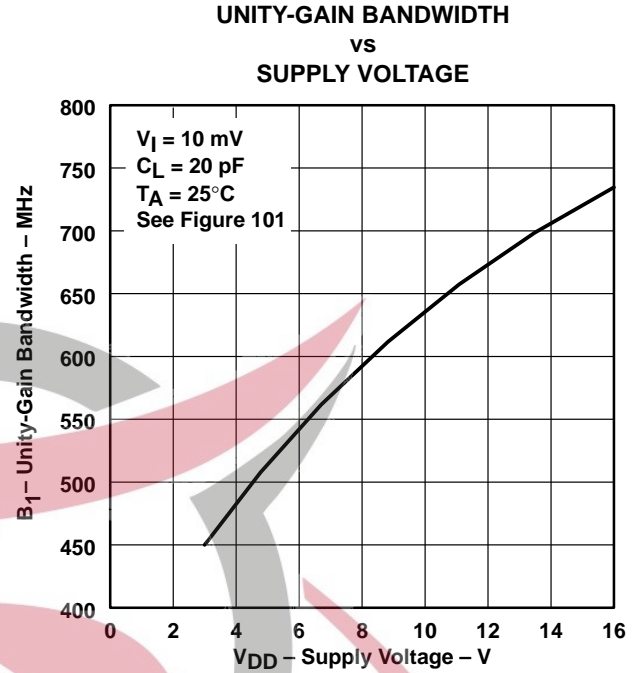

Figure 59

**LARGE-SIGNAL DIFFERENTIAL VOLTAGE
 AMPLIFICATION AND PHASE SHIFT
 VS
 FREQUENCY**

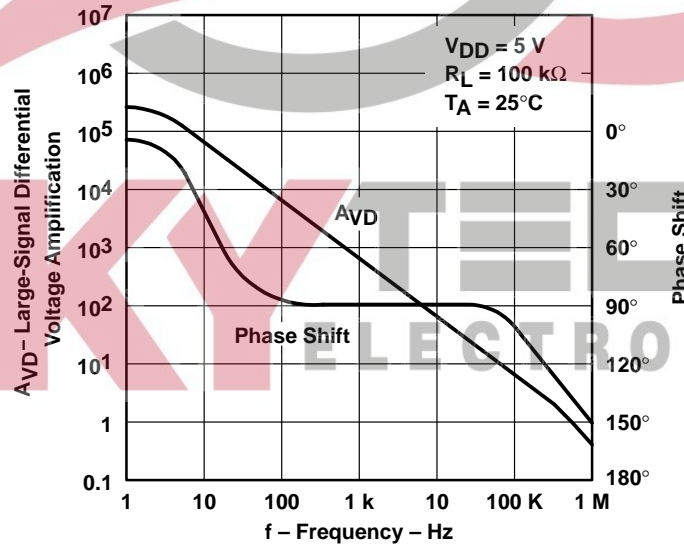

Figure 60

† Data at high and low temperatures are applicable only within the rated operating free-air temperature ranges of the various devices.

TYPICAL CHARACTERISTICS (MEDIUM-BIAS MODE)†

**LARGE-SIGNAL DIFFERENTIAL VOLTAGE
 AMPLIFICATION AND PHASE SHIFT
 vs
 FREQUENCY**

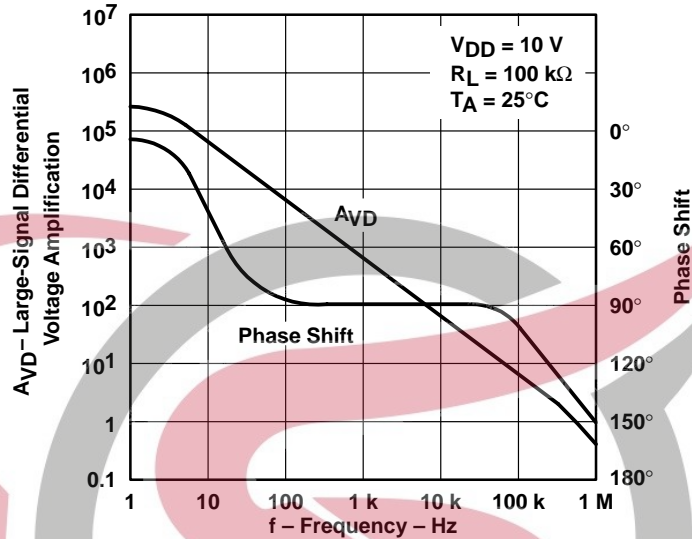

Figure 61

**PHASE MARGIN
 vs
 SUPPLY VOLTAGE**

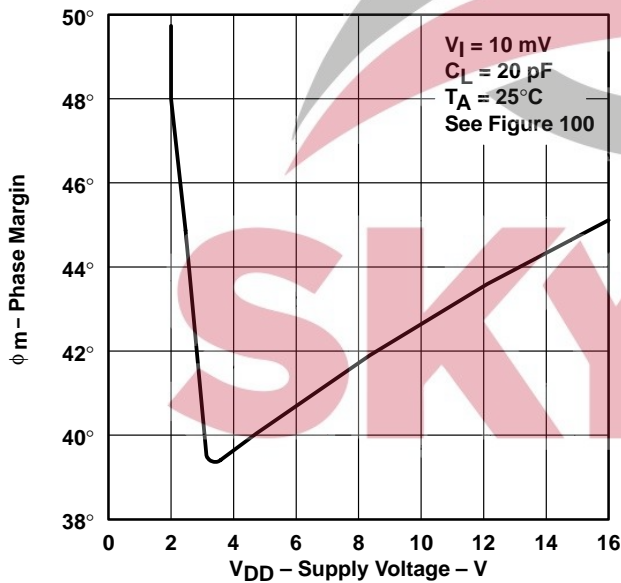

Figure 62

**PHASE MARGIN
 vs
 FREE-AIR TEMPERATURE**

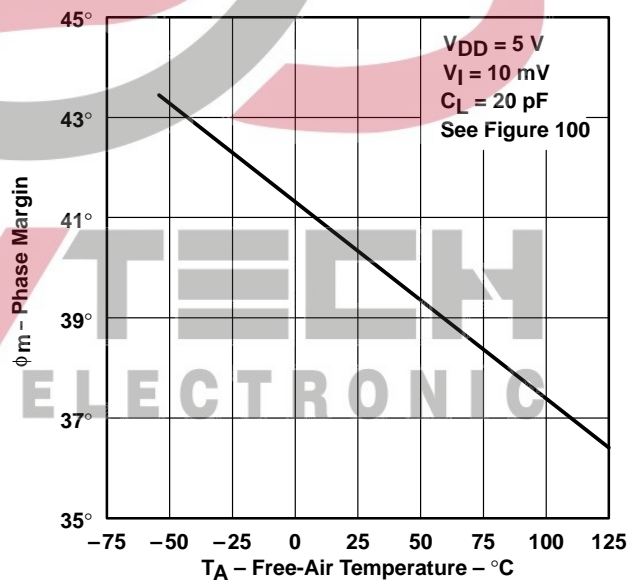

Figure 63

† Data at high and low temperatures are applicable only within the rated operating free-air temperature ranges of the various devices.

TYPICAL CHARACTERISTICS (MEDIUM-BIAS MODE)†

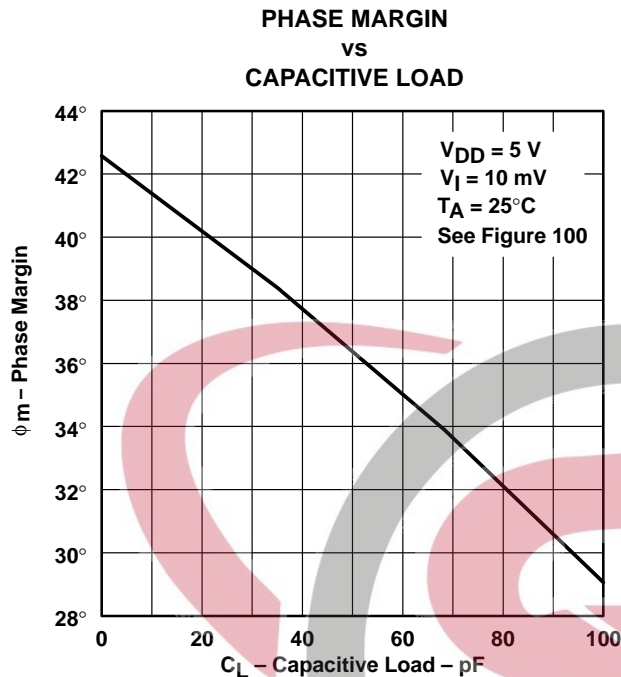

Figure 64

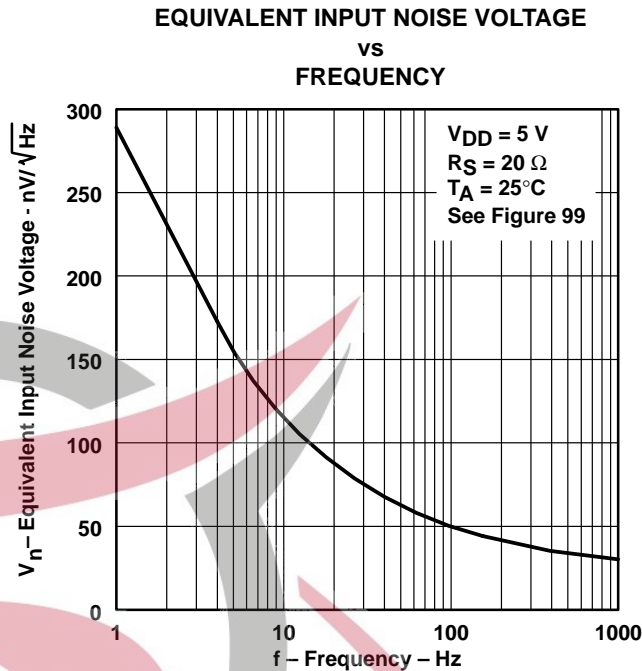

Figure 65

† Data at high and low temperatures are applicable only within the rated operating free-air temperature ranges of the various devices.



TLC271, TLC271A, TLC271B
LinCMOS™ PROGRAMMABLE LOW-POWER
OPERATIONAL AMPLIFIERS

SLOS090D – NOVEMBER 1987 – REVISED MARCH 2001

LOW-BIAS MODE

electrical characteristics at specified free-air temperature (unless otherwise noted)

PARAMETER		TEST CONDITIONS	TA†	TLC271C, TLC271AC, TLC271BC						UNIT	
				VDD = 5 V			VDD = 10 V				
				MIN	TYP	MAX	MIN	TYP	MAX		
VIO	Input offset voltage	VO = 1.4 V, VIC = 0 V, RS = 50 Ω, RI = 1 MΩ	25°C	1.1		10	1.1		10	mV	
			Full range			12			12		
			25°C	0.9		5	0.9		5		
			Full range			6.5			6.5		
αVIO	Average temperature coefficient of input offset voltage		25°C to 70°C	1.1			1			μV/°C	
			IIO	Input offset current (see Note 4)	VO = VDD/2, VIC = VDD/2	25°C	0.1	60	0.1	60	pA
						70°C	7	300	8	300	
						IIB	Input bias current (see Note 4)	VO = VDD/2, VIC = VDD/2	25°C	0.6	
70°C	40	600	50	600							
VICR	Common-mode input voltage range (see Note 5)		25°C	-0.2 to 4	-0.3 to 4.2	-0.2 to 9	-0.3 to 9.2	V			
			Full range	-0.2 to 3.5		-0.2 to 8.5		V			
VOH	High-level output voltage	VID = 100 mV, RL = 1 MΩ	25°C	3.2	4.1	8	8.9	V			
			0°C	3	4.1	7.8	8.9				
			70°C	3	4.2	7.8	8.9				
VOL	Low-level output voltage	VID = -100 mV, IOL = 0	25°C	0	50	0	50	mV			
			0°C	0	50	0	50				
			70°C	0	50	0	50				
AVD	Large-signal differential voltage amplification	RL = 1 MΩ, See Note 6	25°C	50	520	50	870	V/mV			
			0°C	50	700	50	1030				
			70°C	50	380	50	660				
CMRR	Common-mode rejection ratio	VIC = VICRmin	25°C	65	94	65	97	dB			
			0°C	60	95	60	97				
			70°C	60	95	60	97				
kSVR	Supply-voltage rejection ratio (ΔVDD/ΔVIO)	VDD = 5 V to 10 V VO = 1.4 V	25°C	70	97	70	97	dB			
			0°C	60	97	60	97				
			70°C	60	98	60	98				
I(SEL)	Input current (BIAS SELECT)	VI(SEL) = VDD	25°C	65		95		nA			
IDD	Supply current	VO = VDD/2, VIC = VDD/2, No load	25°C	10	17	14	23	μA			
			0°C	12	21	18	33				
			70°C	8	14	11	20				

† Full range is 0°C to 70°C.

- NOTES: 4. The typical values of input bias current and input offset current below 5 pA were determined mathematically.
5. This range also applies to each input individually.
6. At VDD = 5 V, VO = 0.25 V to 2 V; at VDD = 10 V, VO = 1 V to 6 V.



LOW-BIAS MODE

electrical characteristics at specified free-air temperature (unless otherwise noted)

PARAMETER		TEST CONDITIONS	T _A †	TLC271I, TLC271AI, TLC271BI						UNIT	
				V _{DD} = 5 V			V _{DD} = 10 V				
				MIN	TYP	MAX	MIN	TYP	MAX		
V _{IO}	Input offset voltage	V _O = 1.4 V, V _{IC} = 0 V, R _S = 50 Ω, R _L = 1 MΩ	25°C	1.1		10	1.1		10	mV	
			Full range			13			13		
			25°C	0.9		5	0.9		5		
			Full range			7			7		
			25°C	0.24		2	0.26		2		
			Full range			3.5			3.5		
α _{VIO}	Average temperature coefficient of input offset voltage		25°C to 85°C	1.1			1			μV/°C	
I _{IO}	Input offset current (see Note 4)	V _O = V _{DD} /2, V _{IC} = V _{DD} /2	25°C	0.1		60	0.1		60	pA	
			85°C			24	1000		26		1000
I _{IB}	Input bias current (see Note 4)	V _O = V _{DD} /2, V _{IC} = V _{DD} /2	25°C	0.6		60	0.7		60	pA	
			85°C			200	2000		220		2000
V _{ICR}	Common-mode input voltage range (see Note 5)		25°C	-0.2 to 4	-0.3 to 4.2		-0.2 to 9	-0.3 to 9.2		V	
			Full range			-0.2 to 3.5			-0.2 to 8.5		V
V _{OH}	High-level output voltage	V _{ID} = 100 mV, R _L = 1 MΩ	25°C	3		4.1	8		8.9	V	
			-40°C			3	4.1		7.8		8.9
			85°C			3	4.2		7.8		8.9
V _{OL}	Low-level output voltage	V _{ID} = -100 mV, I _{OL} = 0	25°C	0		50	0		50	mV	
			-40°C			0	50		0		50
			85°C			0	50		0		50
A _{VD}	Large-signal differential voltage amplification	R _L = 1 MΩ See Note 6	25°C	50		520	50		870	V/mV	
			-40°C			50	900		50		1550
			85°C			50	330		50		585
CMRR	Common-mode rejection ratio	V _{IC} = V _{ICRmin}	25°C	65		94	65		97	dB	
			-40°C			60	95		60		97
			85°C			60	95		60		98
k _{SVR}	Supply-voltage rejection ratio (ΔV _{DD} /ΔV _{IO})	V _{DD} = 5 V to 10 V V _O = 1.4 V	25°C	70		97	70		97	dB	
			-40°C			60	97		60		97
			85°C			60	98		60		98
I _{I(SEL)}	Input current (BIAS SELECT)	V _{I(SEL)} = V _{DD}	25°C	65			95		nA		
I _{DD}	Supply current	V _O = V _{DD} /2, V _{IC} = V _{DD} /2, No load	25°C	10		17	14		23	μA	
			-40°C			16	27		25		43
			85°C			17	13		10		18

† Full range is -40 to 85°C.

NOTES: 4. The typical values of input bias current and input offset current below 5 pA were determined mathematically.

5. This range also applies to each input individually.

6. At V_{DD} = 5 V, V_O = 0.25 V to 2 V; at V_{DD} = 10 V, V_O = 1 V to 6 V.

TLC271, TLC271A, TLC271B
LinCMOS™ PROGRAMMABLE LOW-POWER
OPERATIONAL AMPLIFIERS

SLOS090D – NOVEMBER 1987 – REVISED MARCH 2001

LOW-BIAS MODE

electrical characteristics at specified free-air temperature (unless otherwise noted)

PARAMETER	TEST CONDITIONS	T _A †	TLC271M						UNIT
			V _{DD} = 5 V			V _{DD} = 10 V			
			MIN	TYP	MAX	MIN	TYP	MAX	
V _{IO} Input offset voltage	V _O = 1.4 V, V _{IC} = 0 V, R _S = 50 Ω, R _L = 1 MΩ	25°C		1.1	10		1.1	10	mV
		Full range					12	12	
α _{VIO} Average temperature coefficient of input offset voltage		25°C to 125°C		1.4			1.4		μV/°C
I _{IO} Input offset current (see Note 4)	V _O = V _{DD} /2, V _{IC} = V _{DD} /2	25°C		0.1	60		0.1	60	pA
		125°C		1.4	15		1.8	15	nA
I _{IB} Input bias current (see Note 4)	V _O = V _{DD} /2, V _{IC} = V _{DD} /2	25°C		0.6	60		0.7	60	pA
		125°C		9	35		10	35	nA
V _{ICR} Common-mode input voltage range (see Note 5)		25°C	0 to 4	-0.3 to 4.2		0 to 9	-0.3 to 9.2		V
		Full range	0 to 3.5		0 to 8.5				V
V _{OH} High-level output voltage	V _{ID} = 100 mV, R _L = 1 MΩ	25°C	3.2	4.1		8	8.9		V
		-55°C	3	4.1		7.8	8.8		
		125°C	3	4.2		7.8	9		
V _{OL} Low-level output voltage	V _{ID} = -100 mV, I _{OL} = 0	25°C		0	50		0	50	mV
		-55°C		0	50		0	50	
		125°C		0	50		0	50	
A _{VD} Large-signal differential voltage amplification	R _L = 1 MΩ, See Note 6	25°C	50	520		50	870		V/mV
		-55°C	25	1000		25	1775		
		125°C	25	200		25	380		
CMRR Common-mode rejection ratio	V _{IC} = V _{ICRmin}	25°C	65	94		65	97		dB
		-55°C	60	95		60	97		
		125°C	60	85		60	91		
k _{SVR} Supply-voltage rejection ratio (ΔV _{DD} /ΔV _{IO})	V _{DD} = 5 V to 10 V V _O = 1.4 V	25°C	70	97		70	97		dB
		-55°C	60	97		60	97		
		125°C	60	98		60	98		
I _{I(SEL)} Input current (BIAS SELECT)	V _{I(SEL)} = V _{DD}	25°C		65		95		nA	
I _{DD} Supply current	V _O = V _{DD} /2, V _{IC} = V _{DD} /2, No load	25°C		10	17		14	23	μA
		-55°C		17	30		28	48	
		125°C		7	12		9	15	

† Full range is -55°C to 125°C.

NOTES: 4. The typical values of input bias current and input offset current below 5 pA were determined mathematically.

5. This range also applies to each input individually.

6. At V_{DD} = 5 V, V_O = 0.25 V to 2 V; at V_{DD} = 10 V, V_O = 1 V to 6 V.



LOW-BIAS MODE

operating characteristics at specified free-air temperature, $V_{DD} = 5\text{ V}$

PARAMETER	TEST CONDITIONS	T_A	TLC271C, TLC271AC, TLC271BC			UNIT
			MIN	TYP	MAX	
SR Slew rate at unity gain	$R_L = 1\text{ M}\Omega$, $C_L = 20\text{ pF}$, See Figure 98	$V_{I(PP)} = 1\text{ V}$	25°C	0.03		V/ μ s
			0°C	0.04		
			70°C	0.03		
		$V_{I(PP)} = 2.5\text{ V}$	25°C	0.03		
			0°C	0.03		
			70°C	0.02		
V_n Equivalent input noise voltage	$f = 1\text{ kHz}$, See Figure 99	$R_S = 20\ \Omega$, 25°C	68		nV/ $\sqrt{\text{Hz}}$	
B_{OM} Maximum output-swing bandwidth	$V_O = V_{OH}$, $R_L = 1\text{ M}\Omega$, $C_L = 20\text{ pF}$, See Figure 98	25°C	5		kHz	
		0°C	6			
		70°C	4.5			
B_1 Unity-gain bandwidth	$V_I = 10\text{ mV}$, See Figure 100	$C_L = 20\text{ pF}$, 25°C	85		kHz	
			0°C	100		
			70°C	65		
ϕ_m Phase margin	$V_I = 10\text{ mV}$, $C_L = 20\text{ pF}$, $f = B_1$, See Figure 100	25°C	34°			
		0°C	36°			
		70°C	30°			

operating characteristics at specified free-air temperature, $V_{DD} = 10\text{ V}$

PARAMETER	TEST CONDITIONS	T_A	TLC271C, TLC271AC, TLC271BC			UNIT
			MIN	TYP	MAX	
SR Slew rate at unity gain	$R_L = 1\text{ M}\Omega$, $C_L = 20\text{ pF}$, See Figure 98	$V_{I(PP)} = 1\text{ V}$	25°C	0.05		V/ μ s
			0°C	0.05		
			70°C	0.04		
		$V_{I(PP)} = 5.5\text{ V}$	25°C	0.04		
			0°C	0.05		
			70°C	0.04		
V_n Equivalent input noise voltage	$f = 1\text{ kHz}$, See Figure 99	$R_S = 20\ \Omega$, 25°C	68		nV/ $\sqrt{\text{Hz}}$	
B_{OM} Maximum output-swing bandwidth	$V_O = V_{OH}$, $R_L = 1\text{ M}\Omega$, $C_L = 20\text{ pF}$, See Figure 98	25°C	1		kHz	
		0°C	1.3			
		70°C	0.9			
B_1 Unity-gain bandwidth	$V_I = 10\text{ mV}$, See Figure 100	$C_L = 20\text{ pF}$, 25°C	110		kHz	
			0°C	125		
			70°C	90		
ϕ_m Phase margin	$V_I = 10\text{ mV}$, $C_L = 20\text{ pF}$, $f = B_1$, See Figure 100	25°C	38°			
		0°C	40°			
		70°C	34°			

TLC271, TLC271A, TLC271B
LinCMOS™ PROGRAMMABLE LOW-POWER
OPERATIONAL AMPLIFIERS

SLOS090D – NOVEMBER 1987 – REVISED MARCH 2001

LOW-BIAS MODE

operating characteristics at specified free-air temperature, $V_{DD} = 5\text{ V}$

PARAMETER	TEST CONDITIONS	T_A	TLC271I, TLC271AI, TLC271BI			UNIT
			MIN	TYP	MAX	
SR Slew rate at unity gain	$R_L = 1\text{ M}\Omega$, $C_L = 20\text{ pF}$, See Figure 98	$V_{I(PP)} = 1\text{ V}$	25°C	0.03		V/ μ s
			-40°C	0.04		
			85°C	0.03		
		$V_{I(PP)} = 2.5\text{ V}$	25°C	0.03		
			-40°C	0.04		
			85°C	0.02		
V_n Equivalent input noise voltage	$f = 1\text{ kHz}$, See Figure 99	$R_S = 20\ \Omega$, 25°C	68		nV/ $\sqrt{\text{Hz}}$	
B_{OM} Maximum output-swing bandwidth	$V_O = V_{OH}$, $R_L = 1\text{ M}\Omega$, See Figure 98	25°C	5		kHz	
		-40°C	7			
		85°C	4			
B_1 Unity-gain bandwidth	$V_I = 10\text{ mV}$, See Figure 100	$C_L = 20\text{ pF}$, 25°C	85		MHz	
		-40°C	130			
		85°C	55			
ϕ_m Phase margin	$V_I = 10\text{ mV}$, $C_L = 20\text{ pF}$,	$f = B_1$, See Figure 100	25°C	34°		
		-40°C	38°			
		85°C	28°			

operating characteristics at specified free-air temperature, $V_{DD} = 10\text{ V}$

PARAMETER	TEST CONDITIONS	T_A	TLC271C, TLC271AC, TLC271BC			UNIT
			MIN	TYP	MAX	
SR Slew rate at unity gain	$R_L = 1\text{ M}\Omega$, $C_L = 20\text{ pF}$, See Figure 98	$V_{I(PP)} = 1\text{ V}$	25°C	0.05		V/ μ s
			-40°C	0.06		
			85°C	0.03		
		$V_{I(PP)} = 5.5\text{ V}$	25°C	0.04		
			-40°C	0.05		
			85°C	0.03		
V_n Equivalent input noise voltage	$f = 1\text{ kHz}$, See Figure 99	$R_S = 20\ \Omega$, 25°C	68		nV/ $\sqrt{\text{Hz}}$	
B_{OM} Maximum output-swing bandwidth	$V_O = V_{OH}$, $R_L = 1\text{ M}\Omega$, See Figure 98	25°C	1		kHz	
		-40°C	1.4			
		85°C	0.8			
B_1 Unity-gain bandwidth	$V_I = 10\text{ mV}$, See Figure 100	$C_L = 20\text{ pF}$, 25°C	110		MHz	
		-40°C	155			
		85°C	80			
ϕ_m Phase margin	$V_I = 10\text{ mV}$, $C_L = 20\text{ pF}$,	$f = B_1$, See Figure 100	25°C	38°		
		-40°C	42°			
		85°C	32°			



LOW-BIAS MODE

operating characteristics at specified free-air temperature, $V_{DD} = 5\text{ V}$

PARAMETER	TEST CONDITIONS	T_A	TLC271M			UNIT
			MIN	TYP	MAX	
SR Slew rate at unity gain	$R_L = 1\text{ M}\Omega$, $C_L = 20\text{ pF}$, See Figure 98	$V_{I(PP)} = 1\text{ V}$	25°C	0.03		V/ μ s
			-55°C	0.04		
			125°C	0.02		
		$V_{I(PP)} = 2.5\text{ V}$	25°C	0.03		
			-55°C	0.04		
			125°C	0.02		
V_n Equivalent input noise voltage	$f = 1\text{ kHz}$, See Figure 99	$R_S = 20\ \Omega$, 25°C	68		nV/ $\sqrt{\text{Hz}}$	
B_{OM} Maximum output-swing bandwidth	$V_O = V_{OH}$, $R_L = 1\text{ M}\Omega$, $C_L = 20\text{ pF}$, See Figure 98	25°C	5		kHz	
		-55°C	8			
		125°C	3			
B_1 Unity-gain bandwidth	$V_I = 10\text{ mV}$, See Figure 100	$C_L = 20\text{ pF}$, 25°C	85		kHz	
			-55°C			140
			125°C			45
ϕ_m Phase margin	$V_I = 10\text{ mV}$, $C_L = 20\text{ pF}$, $f = B_1$, See Figure 100	25°C	34°			
		-55°C	39°			
		125°C	25°			

operating characteristics at specified free-air temperature, $V_{DD} = 10\text{ V}$

PARAMETER	TEST CONDITIONS	T_A	TLC271M			UNIT
			MIN	TYP	MAX	
SR Slew rate at unity gain	$R_L = 1\text{ M}\Omega$, $C_L = 20\text{ pF}$, See Figure 98	$V_{I(PP)} = 1\text{ V}$	25°C	0.05		V/ μ s
			-55°C	0.06		
			125°C	0.03		
		$V_{I(PP)} = 5.5\text{ V}$	25°C	0.04		
			-55°C	0.06		
			125°C	0.03		
V_n Equivalent input noise voltage	$f = 1\text{ kHz}$, See Figure 99	$R_S = 20\ \Omega$, 25°C	68		nV/ $\sqrt{\text{Hz}}$	
B_{OM} Maximum output-swing bandwidth	$V_O = V_{OH}$, $R_L = 1\text{ M}\Omega$, $C_L = 20\text{ pF}$, See Figure 98	25°C	1		kHz	
		-55°C	1.5			
		125°C	0.7			
B_1 Unity-gain bandwidth	$V_I = 10\text{ mV}$, See Figure 100	$C_L = 20\text{ pF}$, 25°C	110		kHz	
			-55°C			165
			125°C			70
ϕ_m Phase margin	$V_I = 10\text{ mV}$, $C_L = 20\text{ pF}$, $f = B_1$, See Figure 100	25°C	38°			
		-55°C	43°			
		125°C	29°			

TLC271, TLC271A, TLC271B
LinCMOS™ PROGRAMMABLE LOW-POWER
OPERATIONAL AMPLIFIERS

SLOS090D – NOVEMBER 1987 – REVISED MARCH 2001

TYPICAL CHARACTERISTICS (LOW-BIAS MODE)

Table of Graphs

		FIGURE	
V_{IO}	Input offset voltage	Distribution	66, 67
α_{VIO}	Temperature coefficient	Distribution	68, 69
V_{OH}	High-level output voltage	vs High-level output current	70, 71
		vs Supply voltage	72
		vs Free-air temperature	73
V_{OL}	Low-level output voltage	vs Common-mode input voltage	74, 75
		vs Differential input voltage	76
		vs Free-air temperature	77
		vs Low-level output current	78, 79
A_{VD}	Large-signal differential voltage amplification	vs Supply voltage	80
		vs Free-air temperature	81
		vs Frequency	92, 93
I_{IB}	Input bias current	vs Free-air temperature	82
I_{IO}	Input offset current	vs Free-air temperature	82
V_I	Maximum input voltage	vs Supply voltage	83
I_{DD}	Supply current	vs Supply voltage	84
		vs Free-air temperature	85
SR	Slew rate	vs Supply voltage	86
		vs Free-air temperature	87
	Bias-select current	vs Supply voltage	88
$V_{O(PP)}$	Maximum peak-to-peak output voltage	vs Frequency	89
B_1	Unity-gain bandwidth	vs Free-air temperature	90
		vs Supply voltage	91
ϕ_m	Phase margin	vs Supply voltage	94
		vs Free-air temperature	95
		vs Capacitive load	96
V_n	Equivalent input noise voltage	vs Frequency	97
		Phase shift	92, 93



POST OFFICE BOX 655303 • DALLAS, TEXAS 75265

TYPICAL CHARACTERISTICS (LOW-BIAS MODE)†

DISTRIBUTION OF TLC271
 INPUT OFFSET VOLTAGE

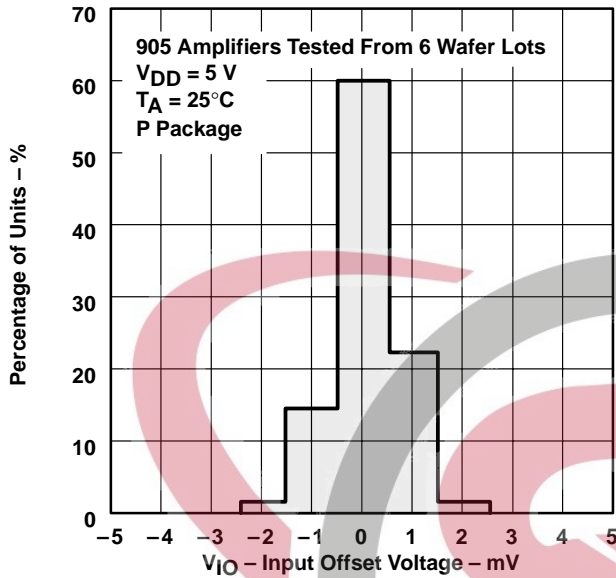

Figure 66

DISTRIBUTION OF TLC271
 INPUT OFFSET VOLTAGE

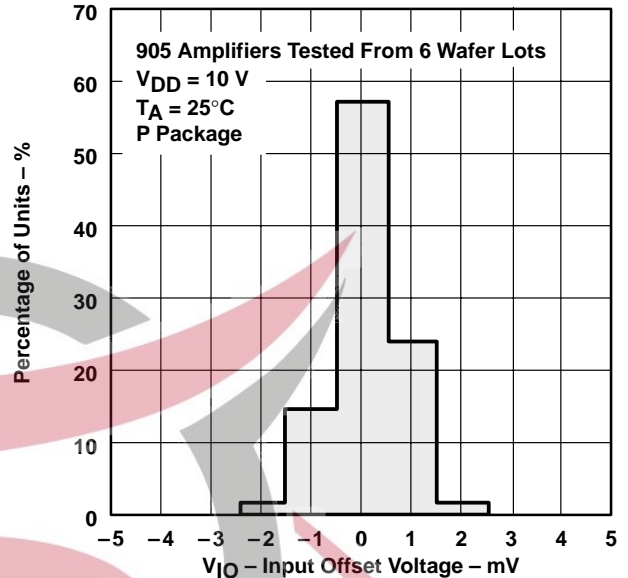

Figure 67

DISTRIBUTION OF TLC271
 INPUT OFFSET VOLTAGE
 TEMPERATURE COEFFICIENT

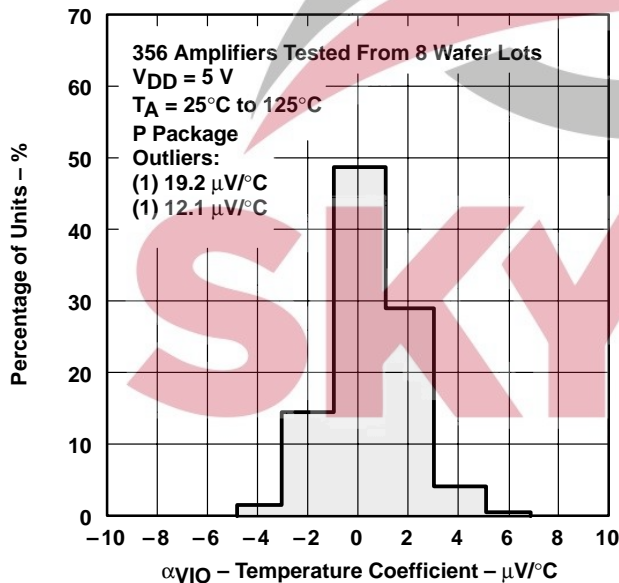

Figure 68

DISTRIBUTION OF TLC271
 INPUT OFFSET VOLTAGE
 TEMPERATURE COEFFICIENT

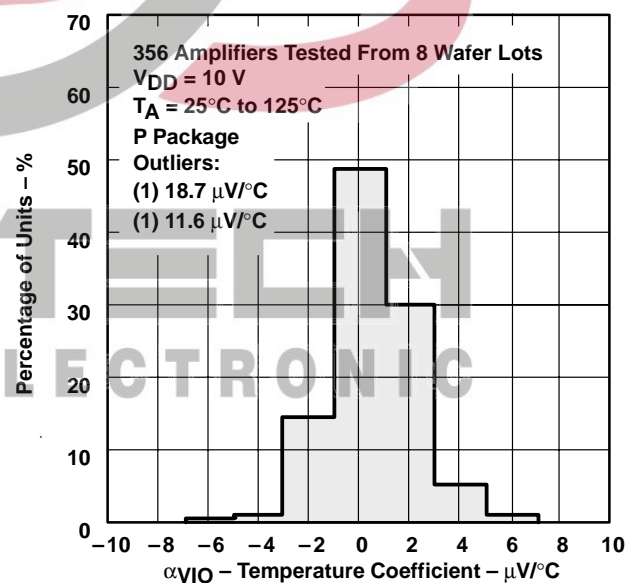

Figure 69

† Data at high and low temperatures are applicable only within the rated operating free-air temperature ranges of the various devices.

TYPICAL CHARACTERISTICS (LOW-BIAS MODE)†

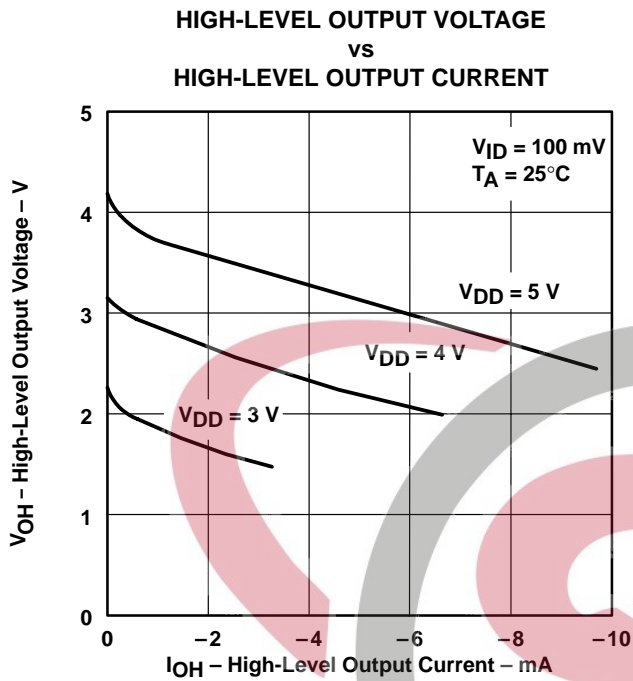

Figure 70

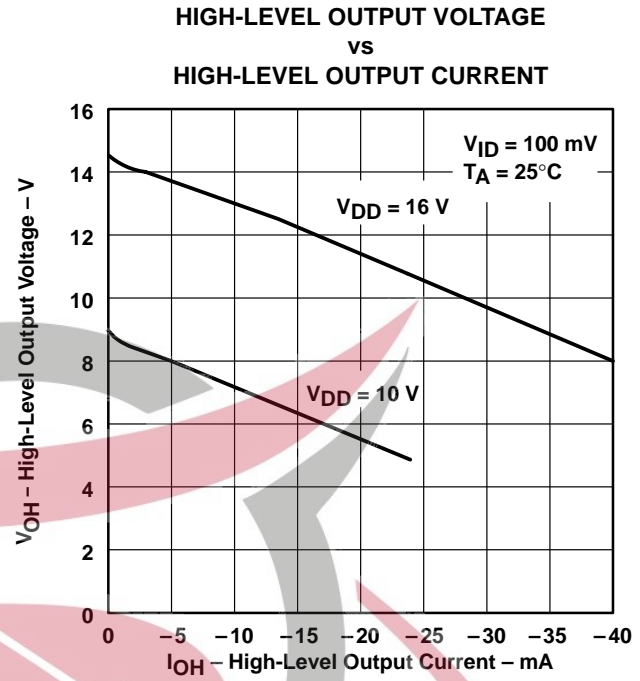

Figure 71

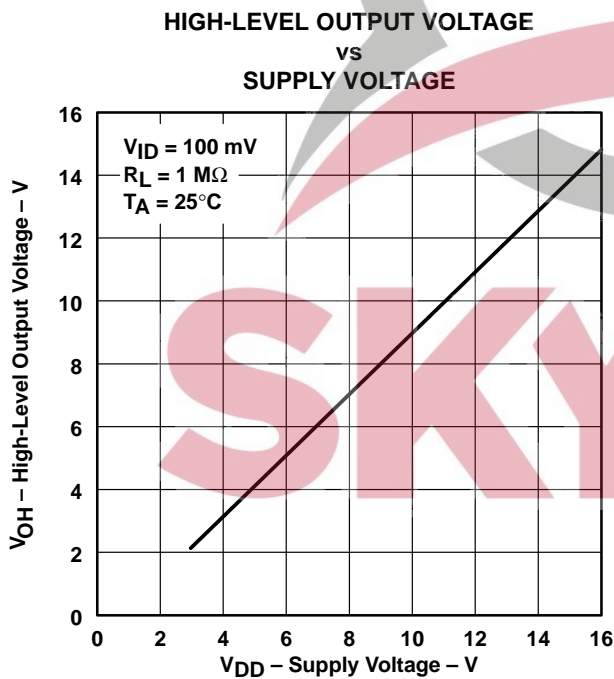

Figure 72

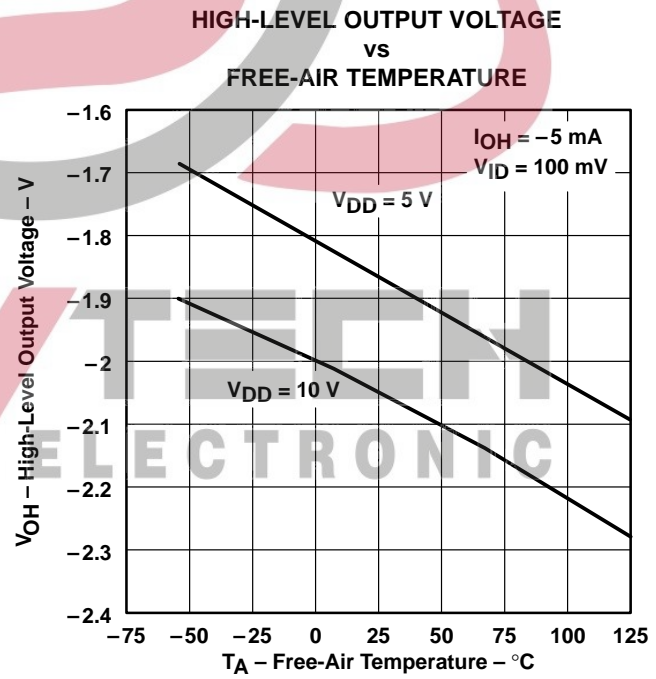

Figure 73

† Data at high and low temperatures are applicable only within the rated operating free-air temperature ranges of the various devices.

TYPICAL CHARACTERISTICS (LOW-BIAS MODE)†

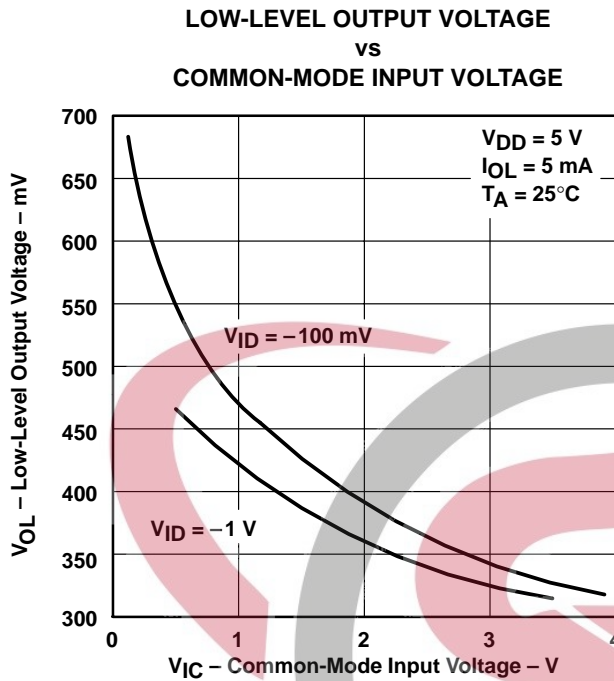

Figure 74

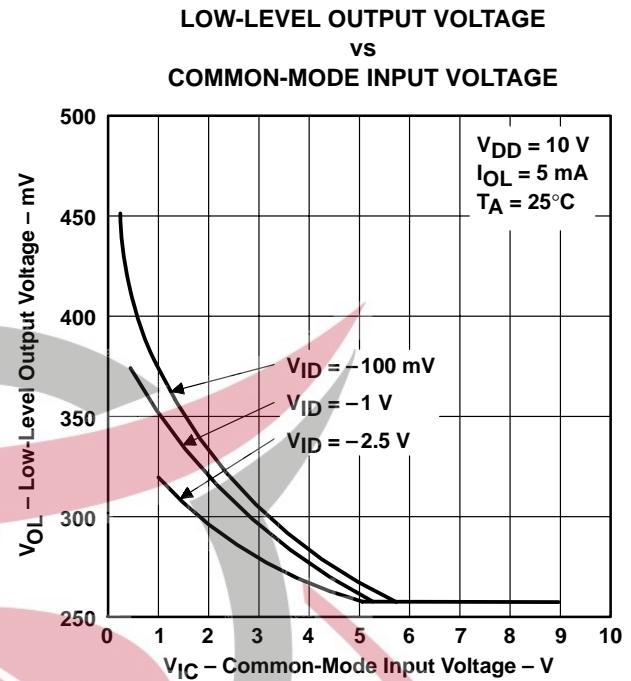

Figure 75

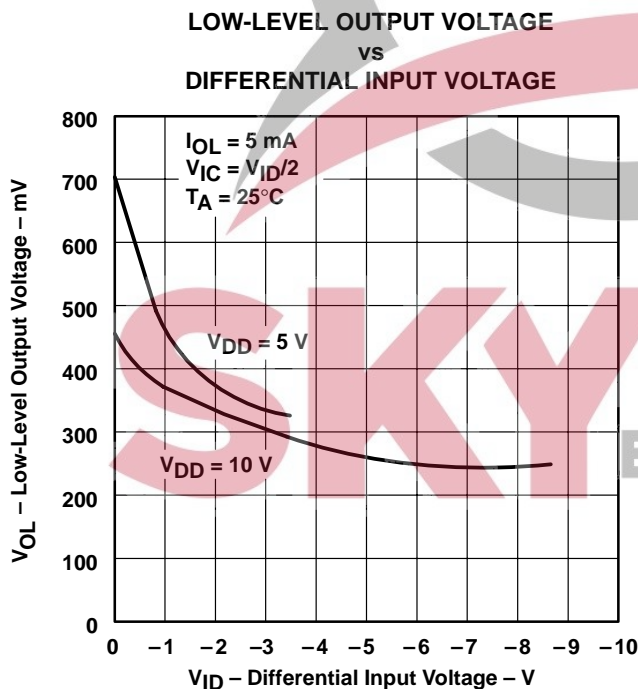

Figure 76

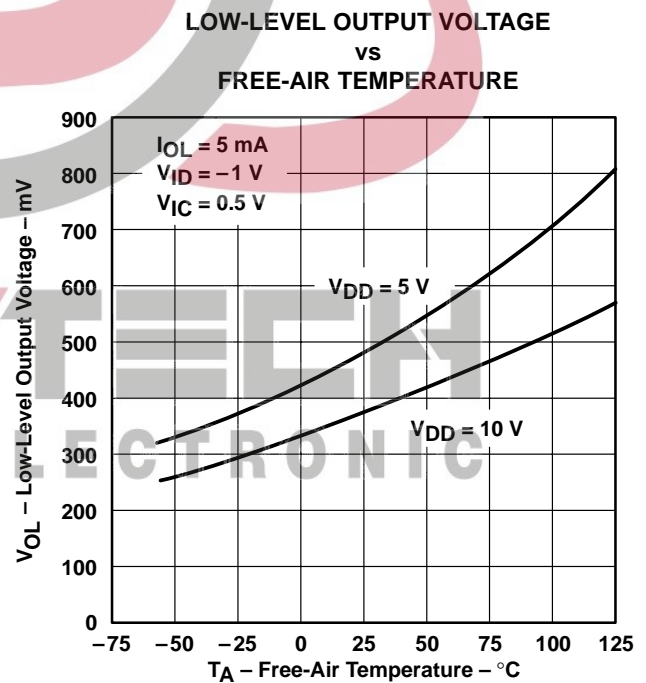

Figure 77

† Data at high and low temperatures are applicable only within the rated operating free-air temperature ranges of the various devices.

TYPICAL CHARACTERISTICS (LOW-BIAS MODE)†

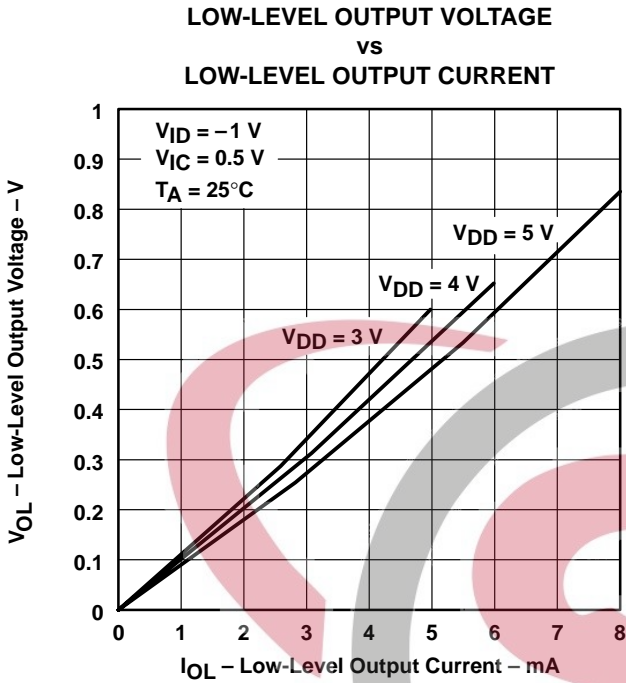

Figure 78

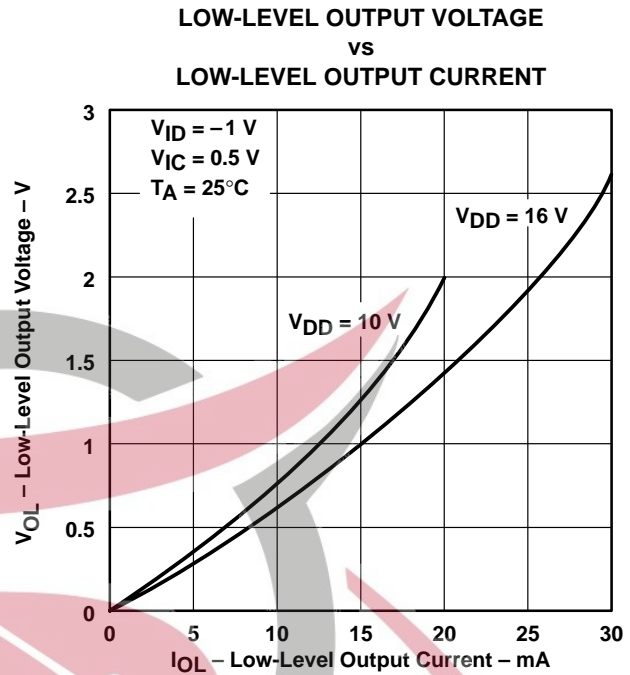

Figure 79

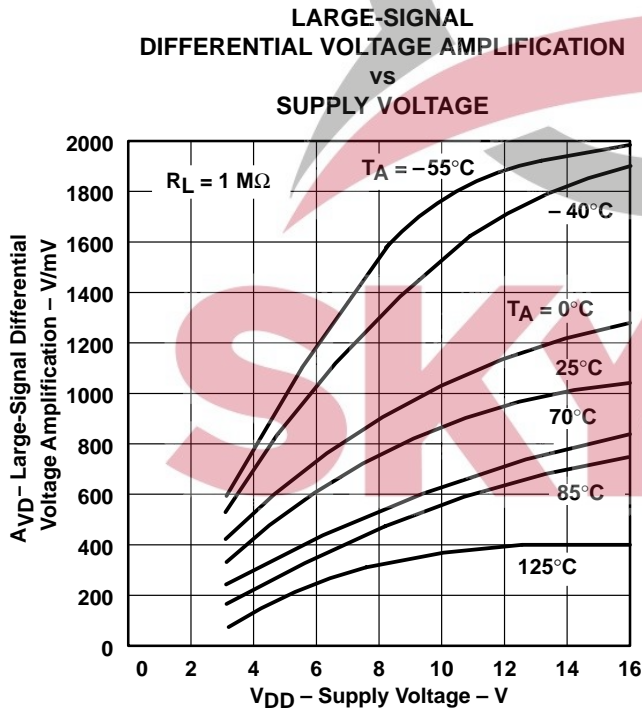

Figure 80

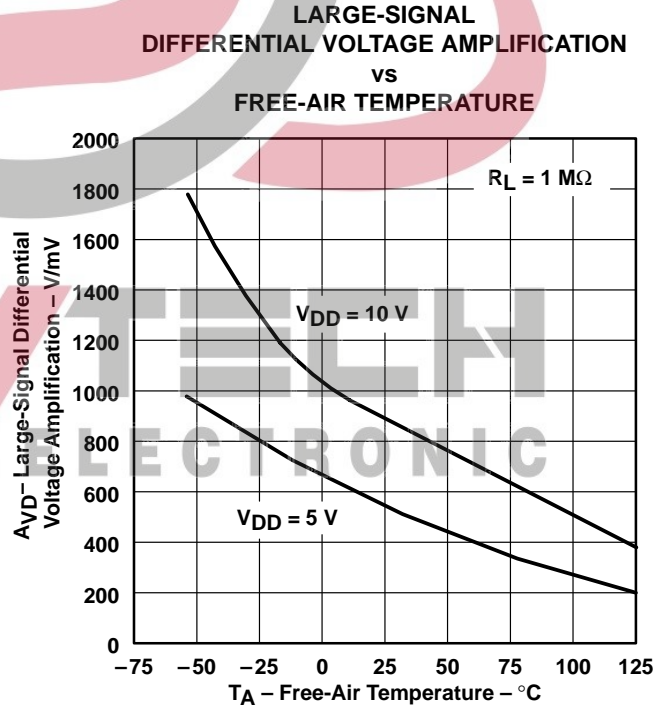
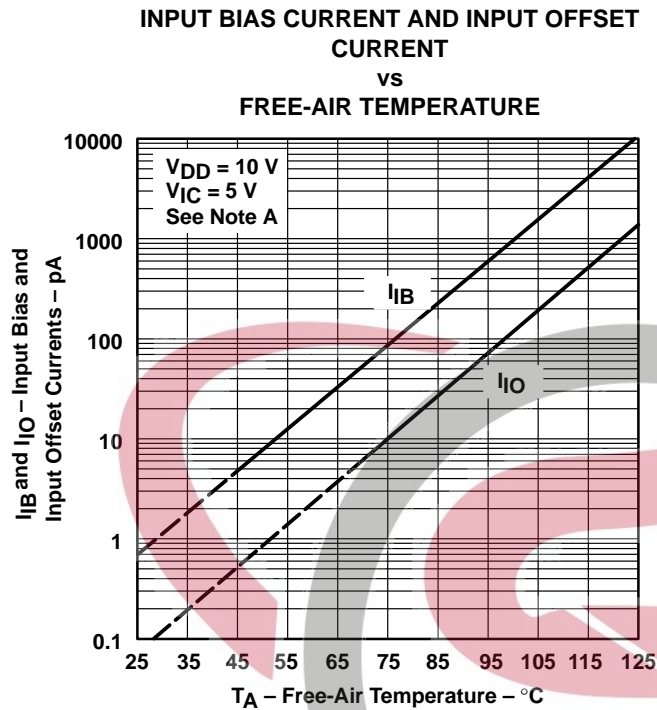

Figure 81

† Data at high and low temperatures are applicable only within the rated operating free-air temperature ranges of the various devices.

TYPICAL CHARACTERISTICS (LOW-BIAS MODE)†



NOTE A: The typical values of input bias current and input offset current below 5 pA were determined mathematically.

Figure 82

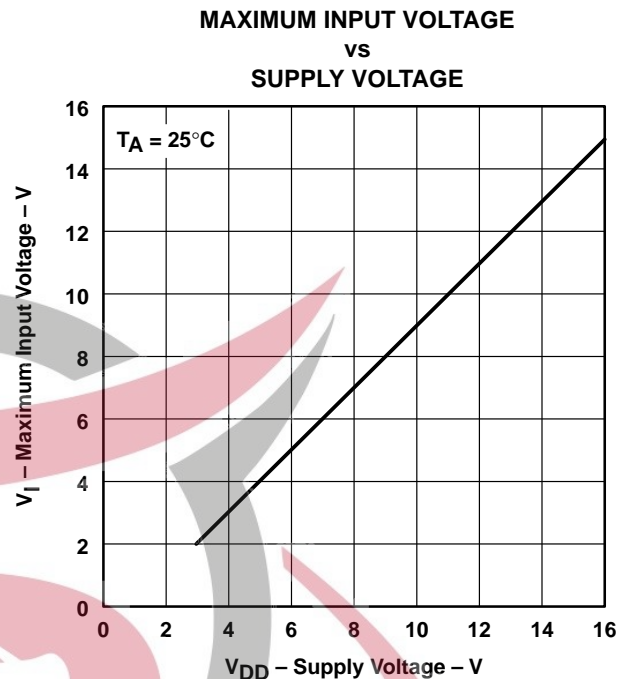

Figure 83

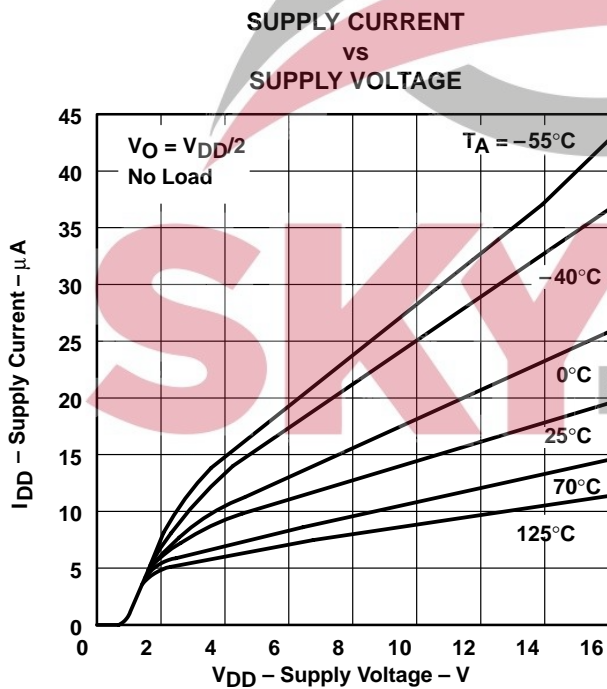

Figure 84

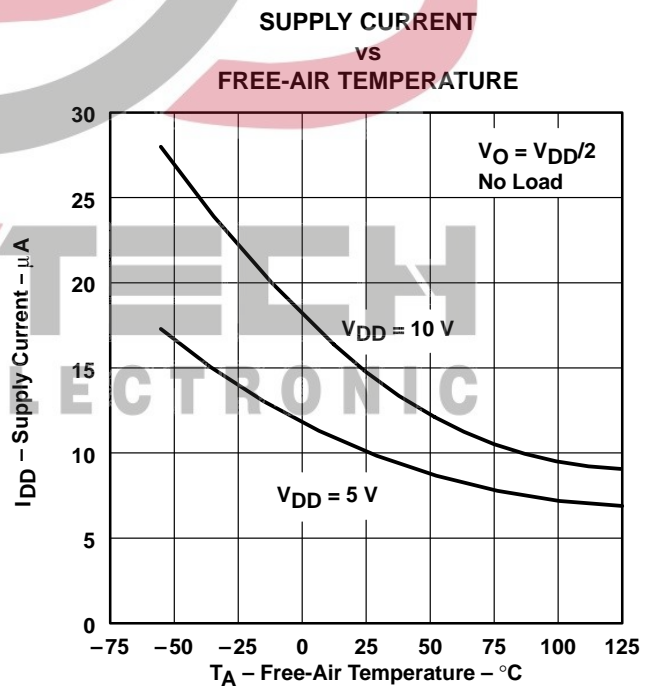

Figure 85

† Data at high and low temperatures are applicable only within the rated operating free-air temperature ranges of the various devices.

TYPICAL CHARACTERISTICS (LOW-BIAS MODE)†

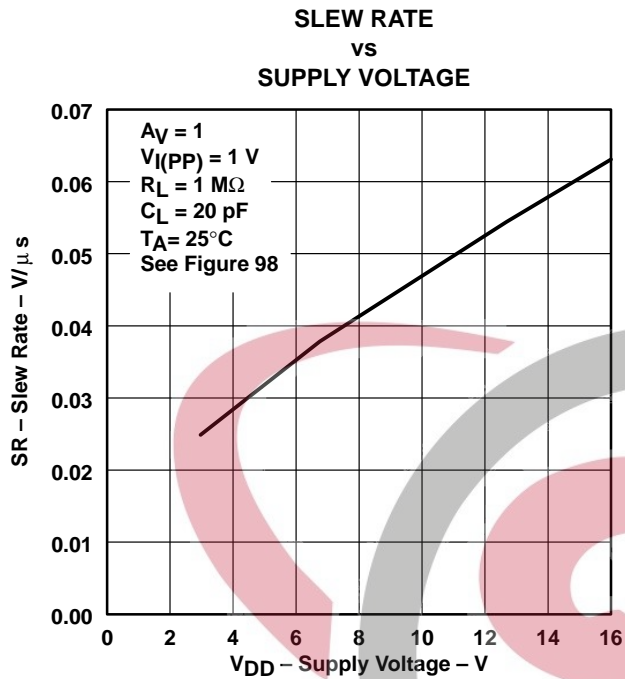

Figure 86

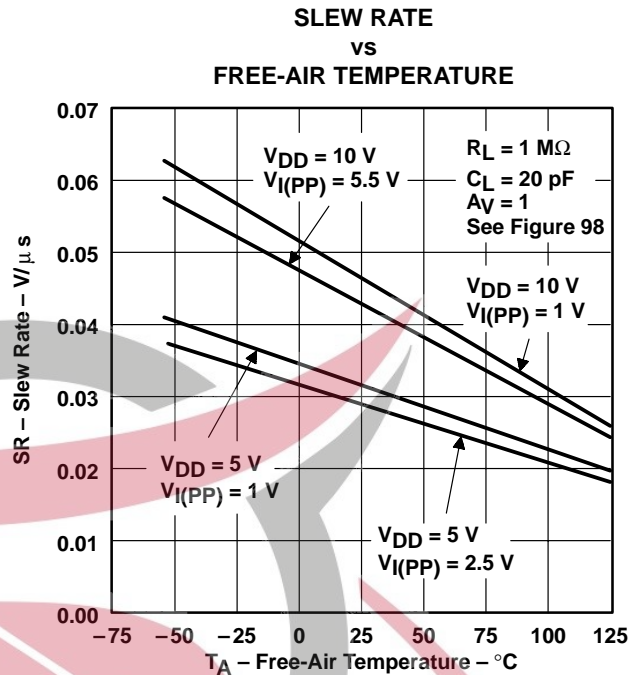

Figure 87

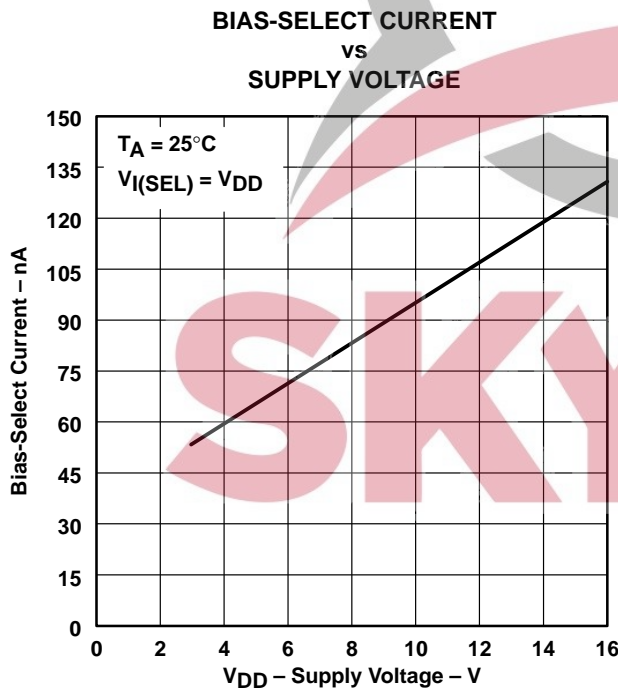

Figure 88

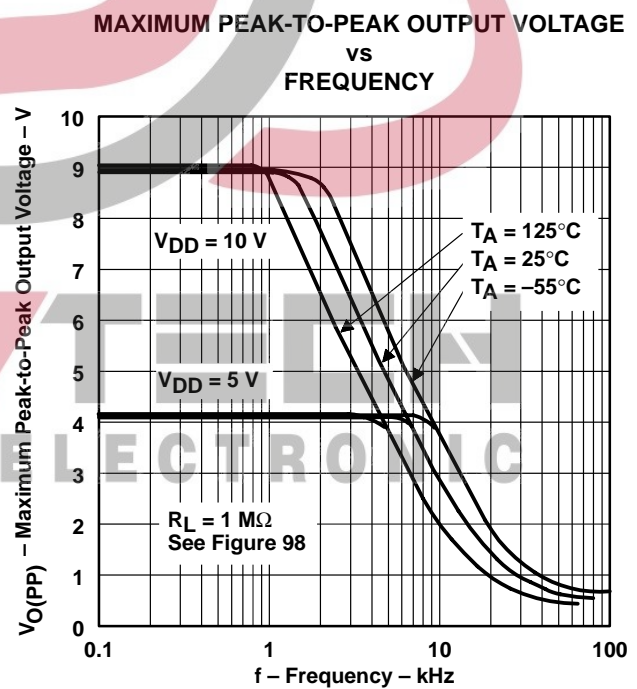

Figure 89

† Data at high and low temperatures are applicable only within the rated operating free-air temperature ranges of the various devices.

TYPICAL CHARACTERISTICS (LOW-BIAS MODE)†

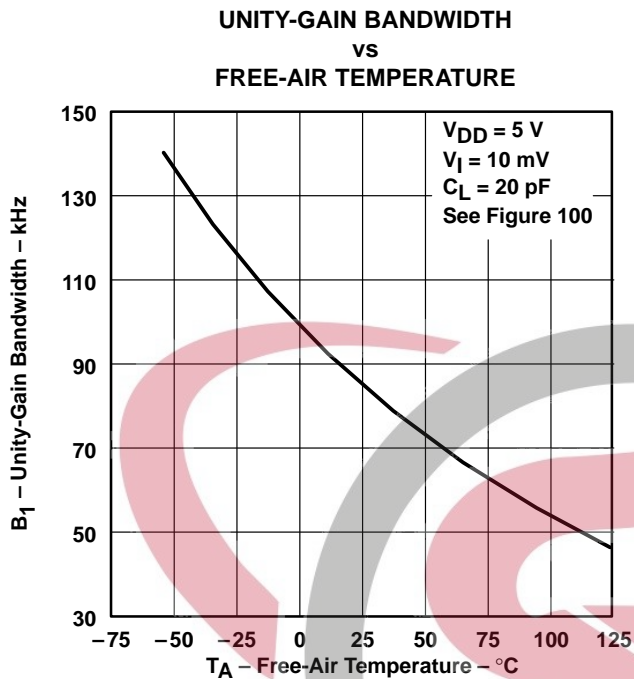

Figure 90

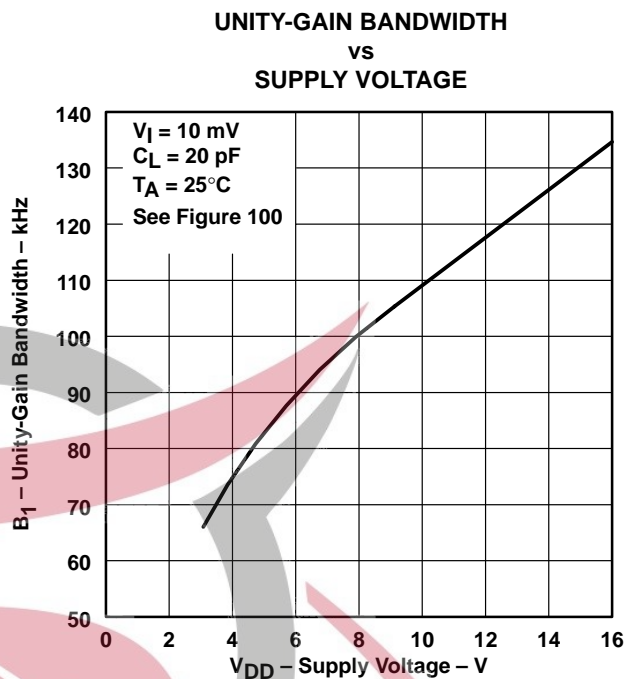

Figure 91

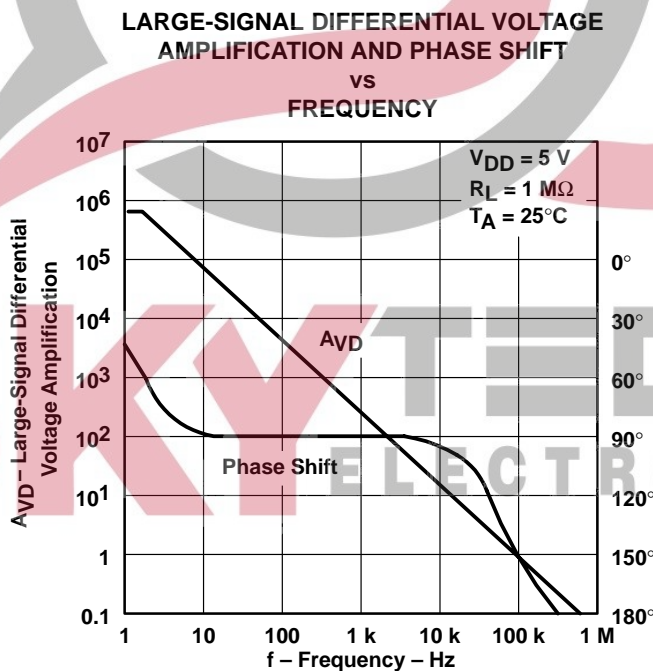

Figure 92

† Data at high and low temperatures are applicable only within the rated operating free-air temperature ranges of the various devices.

TYPICAL CHARACTERISTICS (LOW-BIAS MODE)†

**LARGE-SIGNAL DIFFERENTIAL VOLTAGE
 AMPLIFICATION AND PHASE SHIFT
 vs
 FREQUENCY**

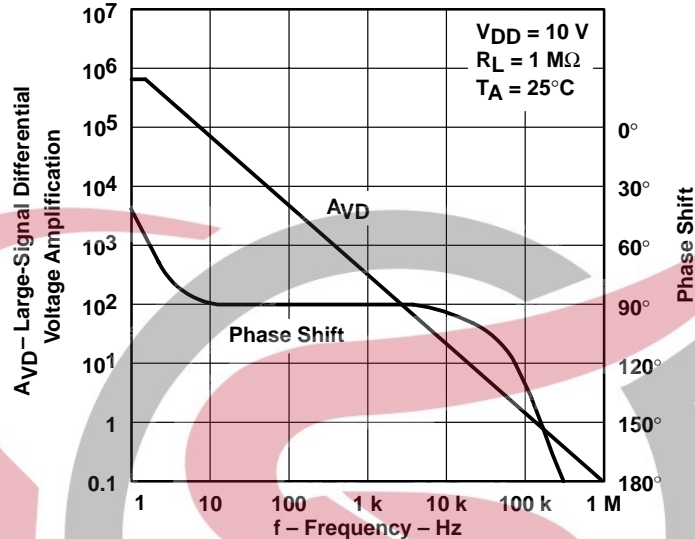

Figure 93

**PHASE MARGIN
 vs
 SUPPLY VOLTAGE**

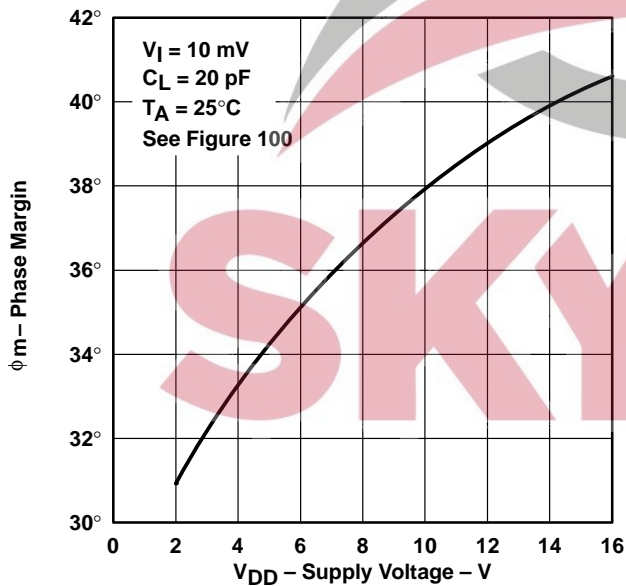

Figure 94

**PHASE MARGIN
 vs
 FREE-AIR TEMPERATURE**

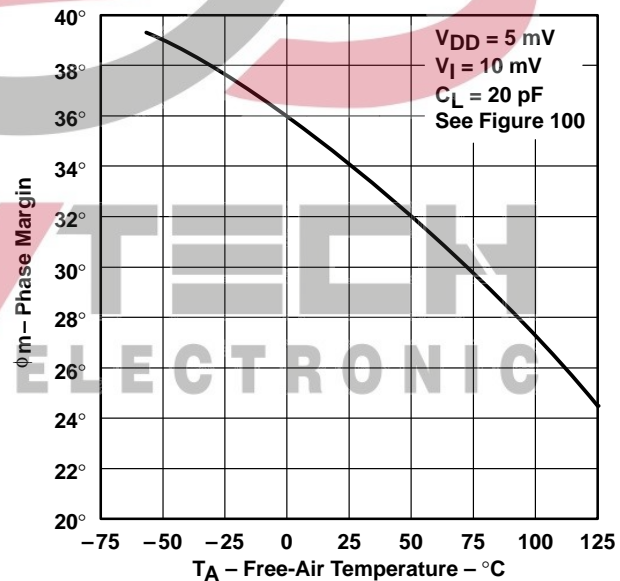

Figure 95

† Data at high and low temperatures are applicable only within the rated operating free-air temperature ranges of the various devices.

TYPICAL CHARACTERISTICS (LOW-BIAS MODE)†

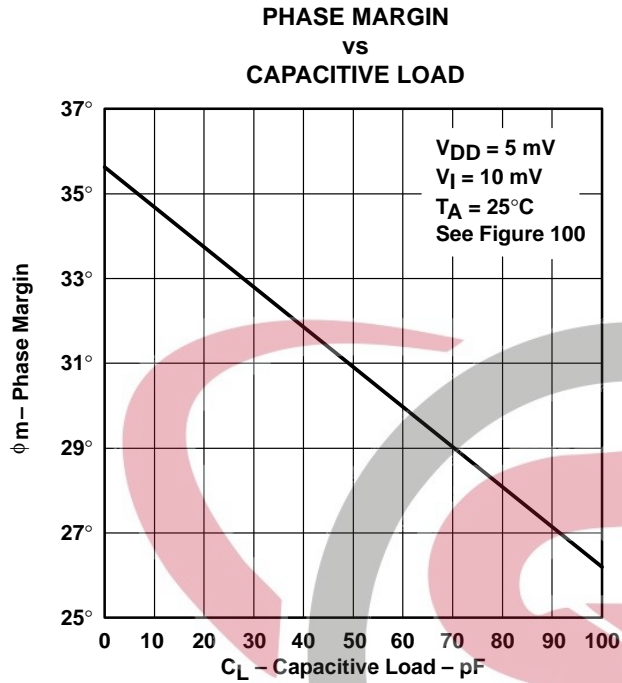

Figure 96

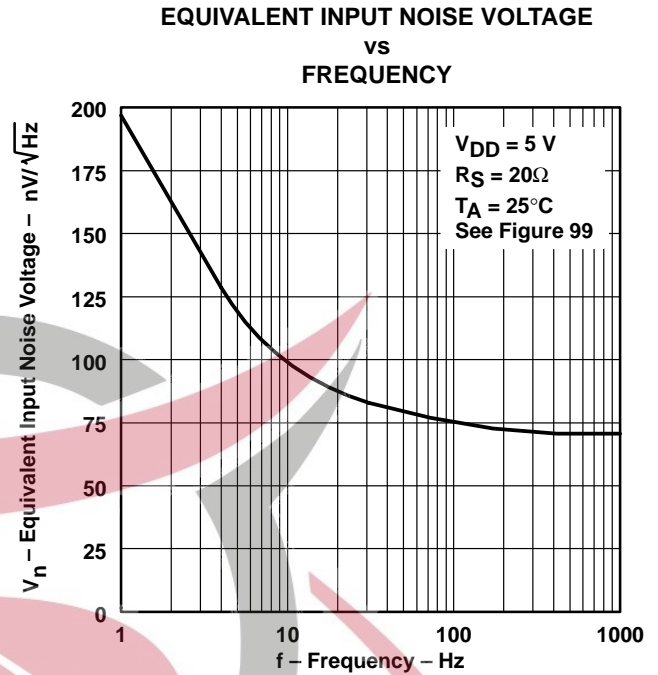

Figure 97

† Data at high and low temperatures are applicable only within the rated operating free-air temperature ranges of the various devices.



PARAMETER MEASUREMENT INFORMATION

single-supply versus split-supply test circuits

Because the TLC271 is optimized for single-supply operation, circuit configurations used for the various tests often present some inconvenience since the input signal, in many cases, must be offset from ground. This inconvenience can be avoided by testing the device with split supplies and the output load tied to the negative rail. A comparison of single-supply versus split-supply test circuits is shown below. The use of either circuit gives the same result.

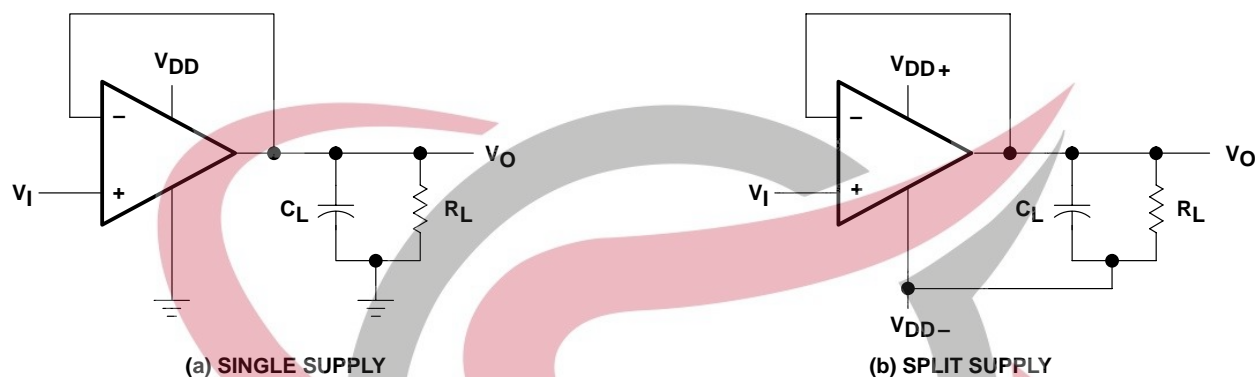

Figure 98. Unity-Gain Amplifier

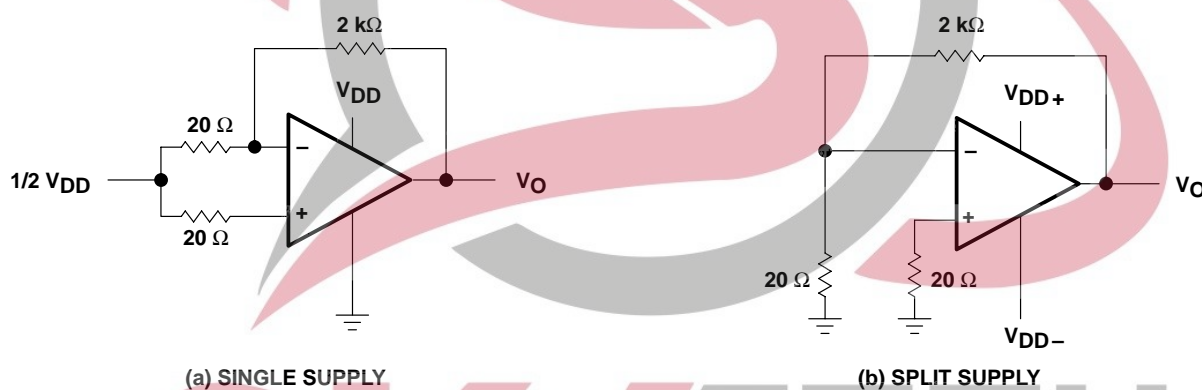

Figure 99. Noise-Test Circuit

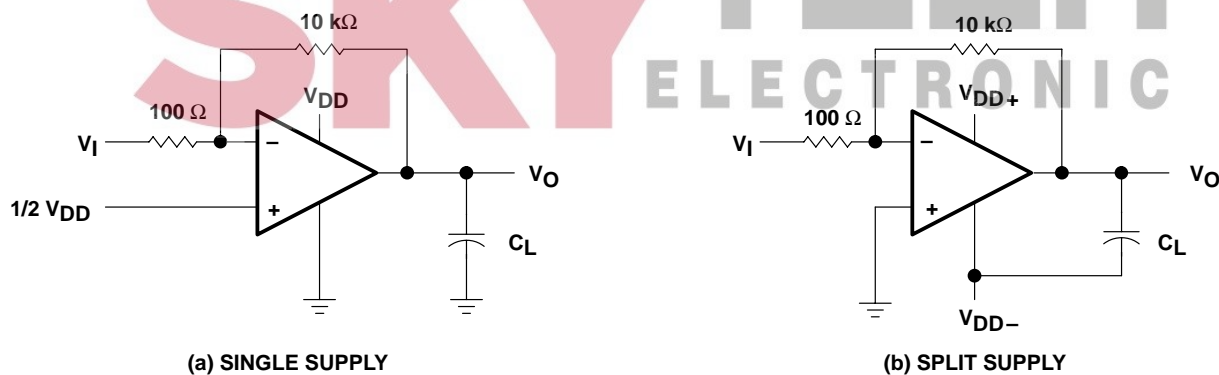

Figure 100. Gain-of-100 Inverting Amplifier

PARAMETER MEASUREMENT INFORMATION

input bias current

Because of the high input impedance of the TLC271 operational amplifiers, attempts to measure the input bias current can result in erroneous readings. The bias current at normal room ambient temperature is typically less than 1 pA, a value that is easily exceeded by leakages on the test socket. Two suggestions are offered to avoid erroneous measurements:

1. Isolate the device from other potential leakage sources. Use a grounded shield around and between the device inputs (see Figure 101). Leakages that would otherwise flow to the inputs are shunted away.
2. Compensate for the leakage of the test socket by actually performing an input bias current test (using a picoammeter) with no device in the test socket. The actual input bias current can then be calculated by subtracting the open-socket leakage readings from the readings obtained with a device in the test socket.

One word of caution: many automatic testers as well as some bench-top operational amplifier testers use the servo-loop technique with a resistor in series with the device input to measure the input bias current (the voltage drop across the series resistor is measured and the bias current is calculated). This method requires that a device be inserted into the test socket to obtain a correct reading; therefore, an open-socket reading is not feasible using this method.

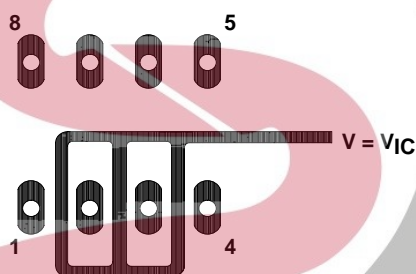

Figure 101. Isolation Metal Around Device inputs (JG and P packages)

low-level output voltage

To obtain low-supply-voltage operation, some compromise is necessary in the input stage. This compromise results in the device low-level output being dependent on both the common-mode input voltage level as well as the differential input voltage level. When attempting to correlate low-level output readings with those quoted in the electrical specifications, these two conditions should be observed. If conditions other than these are to be used, please refer to the Typical Characteristics section of this data sheet.

input offset voltage temperature coefficient

Erroneous readings often result from attempts to measure temperature coefficient of input offset voltage. This parameter is actually a calculation using input offset voltage measurements obtained at two different temperatures. When one (or both) of the temperatures is below freezing, moisture can collect on both the device and the test socket. This moisture results in leakage and contact resistance which can cause erroneous input offset voltage readings. The isolation techniques previously mentioned have no effect on the leakage since the moisture also covers the isolation metal itself, thereby rendering it useless. It is suggested that these measurements be performed at temperatures above freezing to minimize error.

PARAMETER MEASUREMENT INFORMATION

full-power response

Full-power response, the frequency above which the amplifier slew rate limits the output voltage swing, is often specified two ways: full-linear response and full-peak response. The full-linear response is generally measured by monitoring the distortion level of the output while increasing the frequency of a sinusoidal input signal until the maximum frequency is found above which the output contains significant distortion. The full-peak response is defined as the maximum output frequency, without regard to distortion, above which full peak-to-peak output swing cannot be maintained.

Because there is no industry-wide accepted value for significant distortion, the full-peak response is specified in this data sheet and is measured using the circuit of Figure 98. The initial setup involves the use of a sinusoidal input to determine the maximum peak-to-peak output of the device (the amplitude of the sinusoidal wave is increased until clipping occurs). The sinusoidal wave is then replaced with a square wave of the same amplitude. The frequency is then increased until the maximum peak-to-peak output can no longer be maintained (Figure 102). A square wave is used to allow a more accurate determination of the point at which the maximum peak-to-peak output is reached.

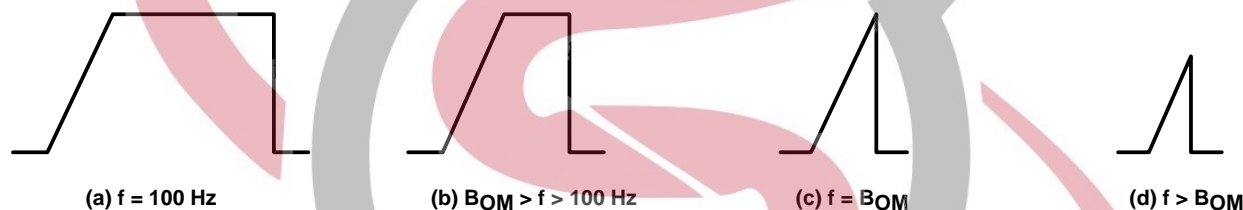

Figure 102. Full-Power-Response Output Signal

test time

Inadequate test time is a frequent problem, especially when testing CMOS devices in a high-volume, short-test-time environment. Internal capacitances are inherently higher in CMOS than in bipolar and BiFET devices, and require longer test times than their bipolar and BiFET counterparts. The problem becomes more pronounced with reduced supply levels and lower temperatures.

APPLICATION INFORMATION

single-supply operation

While the TLC271 performs well using dual power supplies (also called balanced or split supplies), the design is optimized for single-supply operation. This includes an input common mode voltage range that encompasses ground as well as an output voltage range that pulls down to ground. The supply voltage range extends down to 3 V (C-suffix types), thus allowing operation with supply levels commonly available for TTL and HCMOS; however, for maximum dynamic range, 16-V single-supply operation is recommended.

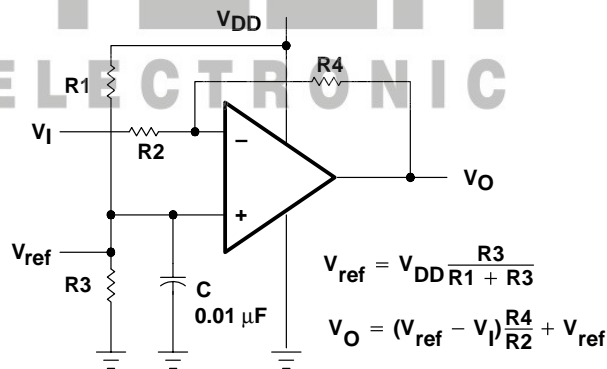

Figure 103. Inverting Amplifier With Voltage Reference

APPLICATION INFORMATION

single-supply operation (continued)

Many single-supply applications require that a voltage be applied to one input to establish a reference level that is above ground. A resistive voltage divider is usually sufficient to establish this reference level (see Figure 103). The low input bias current consumption of the TLC271 permits the use of very large resistive values to implement the voltage divider, thus minimizing power consumption.

The TLC271 works well in conjunction with digital logic; however, when powering both linear devices and digital logic from the same power supply, the following precautions are recommended:

1. Power the linear devices from separate bypassed supply lines (see Figure 104); otherwise, the linear device supply rails can fluctuate due to voltage drops caused by high switching currents in the digital logic.
2. Use proper bypass techniques to reduce the probability of noise-induced errors. Single capacitive decoupling is often adequate; however, RC decoupling may be necessary in high-frequency applications.

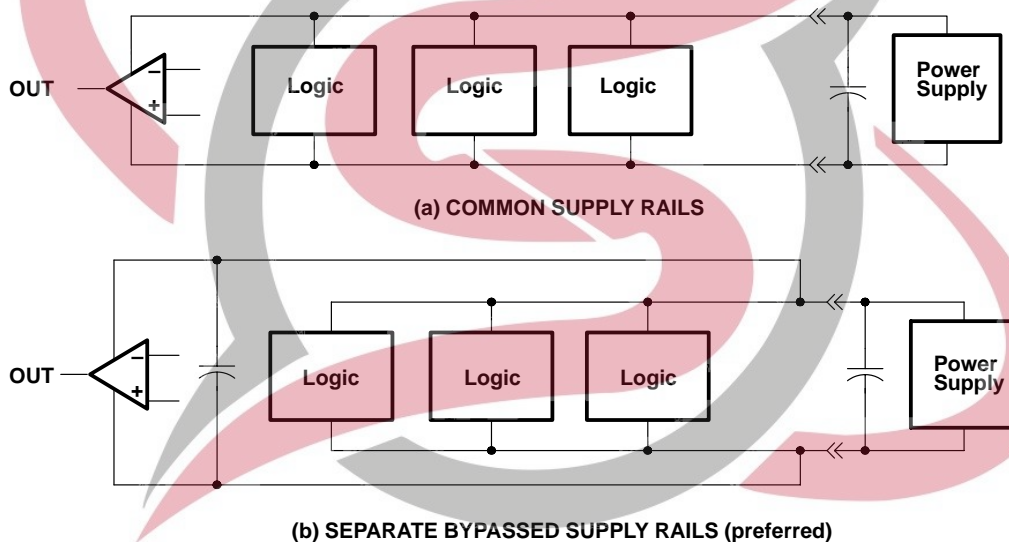

Figure 104. Common Versus Separate Supply Rails



APPLICATION INFORMATION

input offset voltage nulling

The TLC271 offers external input offset null control. Nulling of the input off set voltage may be achieved by adjusting a 25-kΩ potentiometer connected between the offset null terminals with the wiper Connected as shown in Figure 105. The amount of nulling range varies with the bias selection. In the high-bias mode, the nulling range allows the maximum offset voltage specified to be trimmed to zero. In low-bias and medium-bias modes, total nulling may not be possible.

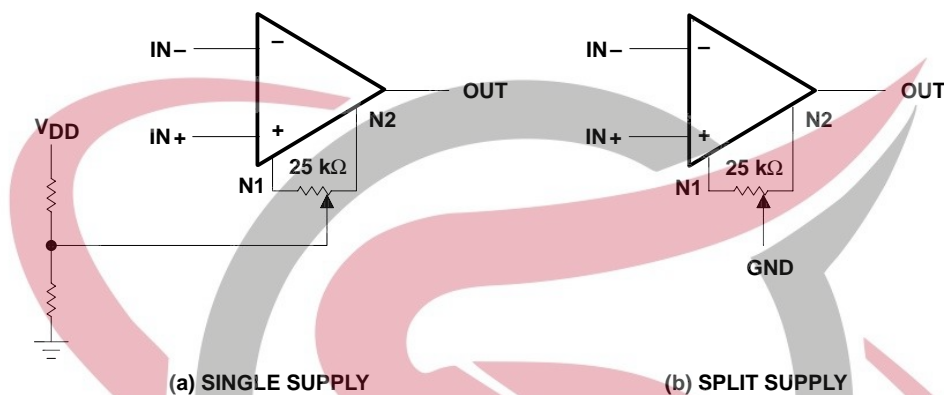

Figure 105. Input Offset Voltage Null Circuit

bias selection

Bias selection is achieved by connecting the bias select pin to one of the three voltage levels (see Figure 106). For medium-bias applications, R is recommended that the bias select pin be connected to the mid-point between the supply rails. This is a simple procedure in split-supply applications, since this point is ground. In single-supply applications, the medium-bias mode necessitates using a voltage divider as indicated. The use of large-value resistors in the voltage divider reduces the current drain of the divider from the supply line. However, large-value resistors used in conjunction with a large-value capacitor requires significant time to charge up to the supply midpoint after the supply is switched on. A voltage other than the midpoint may be used if it is within the voltages specified in the table of Figure 106.

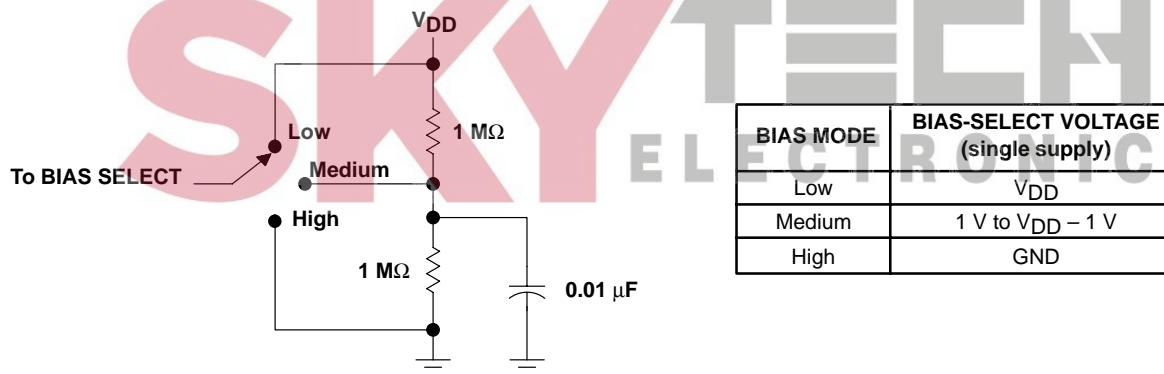

Figure 106. Bias Selection for Single-Supply Applications

APPLICATION INFORMATION

input characteristics

The TLC271 is specified with a minimum and a maximum input voltage that, if exceeded at either input, could cause the device to malfunction. Exceeding this specified range is a common problem, especially in single-supply operation. Note that the lower range limit includes the negative rail, while the upper range limit is specified at $V_{DD} - 1$ V at $T_A = 25^\circ\text{C}$ and at $V_{DD} - 1.5$ V at all other temperatures.

The use of the polysilicon-gate process and the careful input circuit design gives the TLC271 very good input offset voltage drift characteristics relative to conventional metal-gate processes. Offset voltage drift in CMOS devices is highly influenced by threshold voltage shifts caused by polarization of the phosphorus dopant implanted in the oxide. Placing the phosphorus dopant in a conductor (such as a polysilicon gate) alleviates the polarization problem, thus reducing threshold voltage shifts by more than an order of magnitude. The offset voltage drift with time has been calculated to be typically $0.1 \mu\text{V}/\text{month}$, including the first month of operation.

Because of the extremely high input impedance and resulting low bias current requirements, the TLC271 is well suited for low-level signal processing; however, leakage currents on printed circuit boards and sockets can easily exceed bias current requirements and cause a degradation in device performance. It is good practice to include guard rings around inputs (similar to those of Figure 101 in the Parameter Measurement Information section). These guards should be driven from a low-impedance source at the same voltage level as the common-mode input (see Figure 107).

The inputs of any unused amplifiers should be tied to ground to avoid possible oscillation.

noise performance

The noise specifications in operational amplifier circuits are greatly dependent on the current in the first-stage differential amplifier. The low input bias current requirements of the TLC271 results in a very low noise current, which is insignificant in most applications. This feature makes the devices especially favorable over bipolar devices when using values of circuit impedance greater than $50 \text{ k}\Omega$, since bipolar devices exhibit greater noise currents.

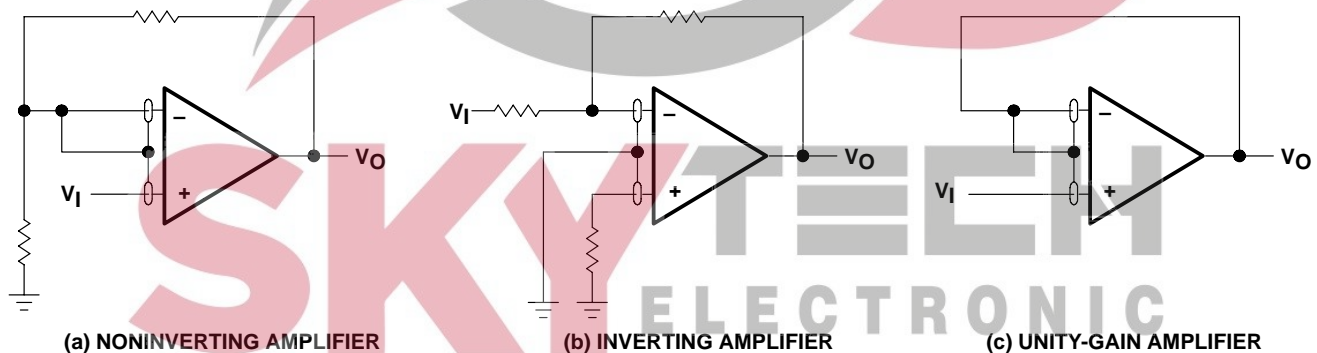

Figure 107. Guard-Ring Schemes

APPLICATION INFORMATION

feedback

Operational amplifier circuits almost always employ feedback, and since feedback is the first prerequisite for oscillation, a little caution is appropriate. Most oscillation problems result from driving capacitive loads and ignoring stray input capacitance. A small-value capacitor connected in parallel with the feedback resistor is an effective remedy (see Figure 108). The value of this capacitor is optimized empirically.

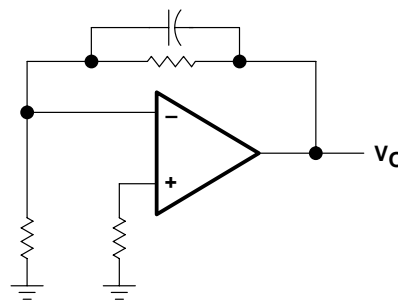

Figure 108. Compensation for Input Capacitance

electrostatic discharge protection

The TLC271 incorporates an internal electrostatic-discharge (ESD) protection circuit that prevents functional failures at voltages up to 2000 V as tested under MIL-STD-883C, Method 3015.2. Care should be exercised, however, when handling these devices as exposure to ESD may result in the degradation of the device parametric performance. The protection circuit also causes the input bias currents to be temperature dependent and have the characteristics of a reverse-biased diode.

latch-up

Because CMOS devices are susceptible to latch-up due to their inherent parasitic thyristors, the TLC271 inputs and output were designed to withstand –100-mA surge currents without sustaining latchup; however, techniques should be used to reduce the chance of latch-up whenever possible. Internal protection diodes should not by design be forward biased. Applied input and output voltage should not exceed the supply voltage by more than 300 mV. Care should be exercised when using capacitive coupling on pulse generators. Supply transients should be shunted by the use of decoupling capacitors (0.1 μF typical) located across the supply rails as close to the device as possible.

The current path established if latch-up occurs is usually between the positive supply rail and ground and can be triggered by surges on the supply lines and/or voltages on either the output or inputs that exceed the supply voltage. Once latch-up occurs, the current flow is limited only by the impedance of the power supply and the forward resistance of the parasitic thyristor and usually results in the destruction of the device. The chance of latch-up occurring increases with increasing temperature and supply voltages.

output characteristics

The output stage of the TLC271 is designed to sink and source relatively high amounts of current (see Typical Characteristics). If the output is subjected to a short-circuit condition, this high current capability can cause device damage under certain conditions. Output current capability increases with supply voltage.

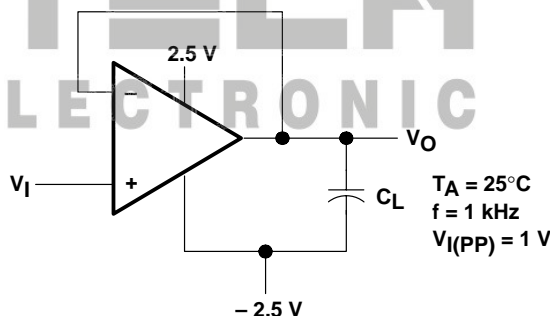

Figure 109. Test Circuit for Output Characteristics

APPLICATION INFORMATION

output characteristics (continued)

All operating characteristics of the TLC271 were measured using a 20-pF load. The devices drive higher capacitive loads; however, as output load capacitance increases, the resulting response pole occurs at lower frequencies, thereby causing ringing, peaking, or even oscillation (see Figures 110, 111, and 112). In many cases, adding some compensation in the form of a series resistor in the feedback loop alleviates the problem.

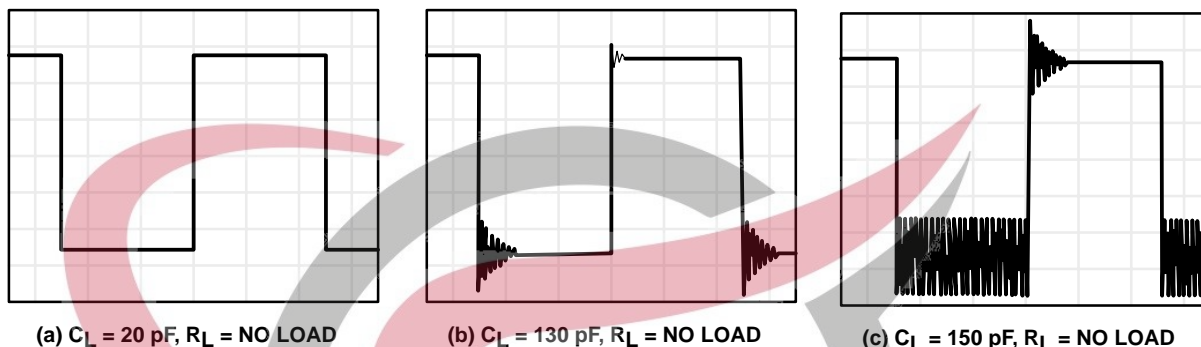

Figure 110. Effect of Capacitive Loads in High-Bias Mode

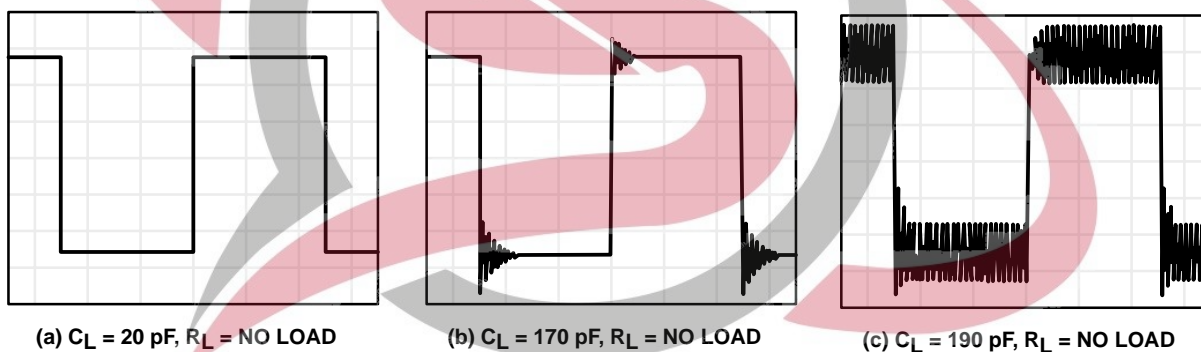

Figure 111. Effect of Capacitive Loads in Medium-Bias Mode

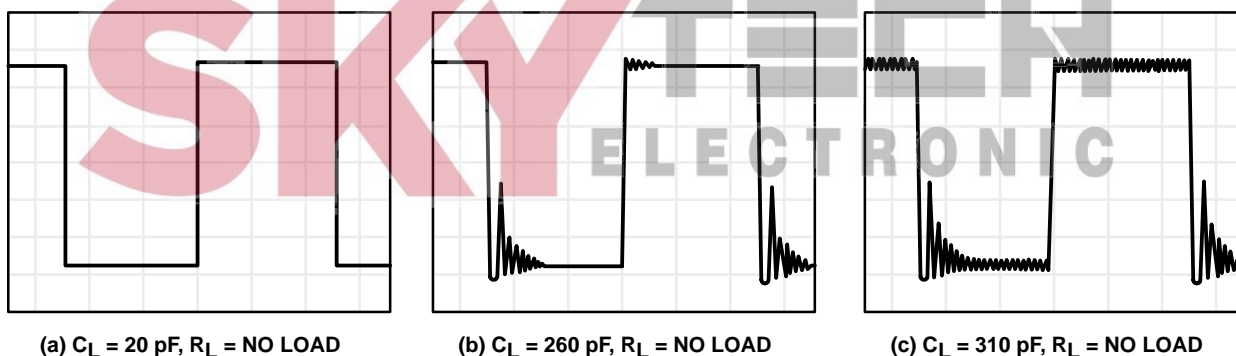

Figure 112. Effect of Capacitive Loads in Low-Bias Mode

APPLICATION INFORMATION

output characteristics (continued)

Although the TLC271 possesses excellent high-level output voltage and current capability, methods are available for boosting this capability, if needed. The simplest method involves the use of a pullup resistor (R_P) connected from the output to the positive supply rail (see Figure 113). There are two disadvantages to the use of this circuit. First, the NMOS pulldown transistor, N4 (see equivalent schematic) must sink a comparatively large amount of current. In this circuit, N4 behaves like a linear resistor with an on-resistance between approximately 60Ω and 180Ω , depending on how hard the operational amplifier input is driven. With very low values of R_P , a voltage offset from 0 V at the output occurs. Secondly, pullup resistor R_P acts as a drain load to N4 and the gain of the operational amplifier is reduced at output voltage levels where N5 is not supplying the output current.

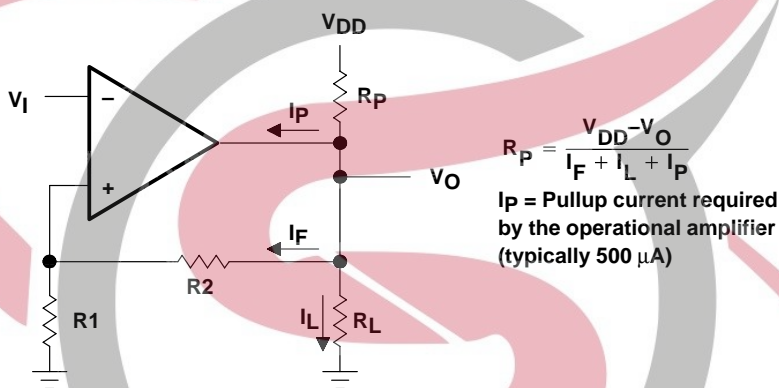
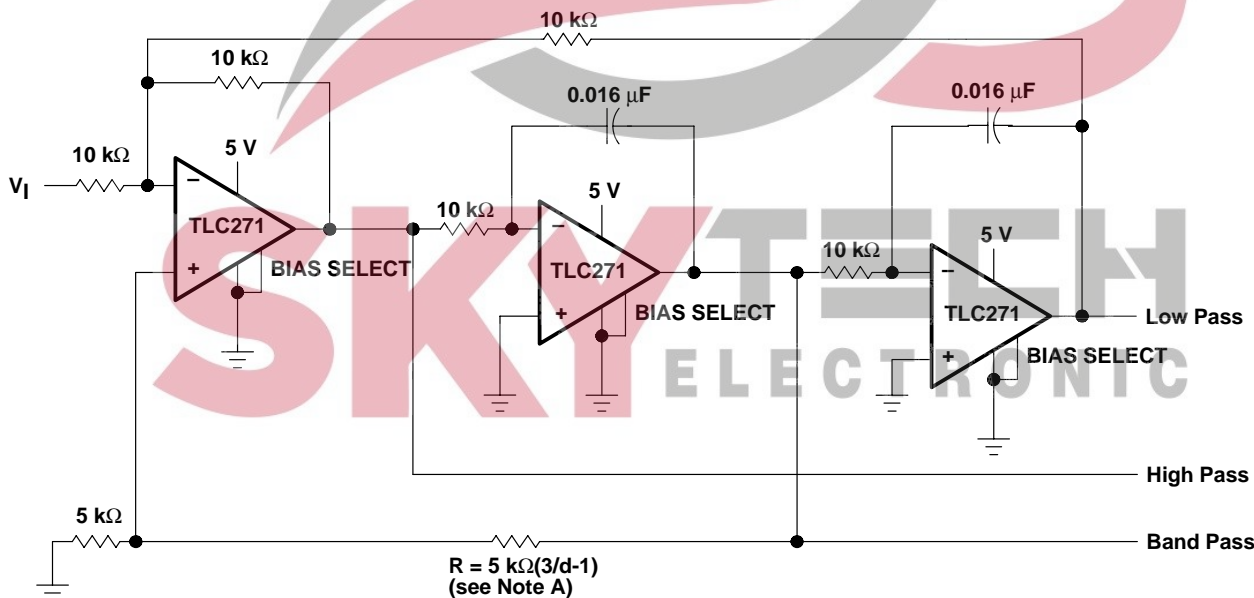

Figure 113. Resistive Pullup to Increase V_{OH}



NOTE B: d = damping factor, I/O

Figure 114. State-Variable Filter

APPLICATION INFORMATION

output characteristics (continued)

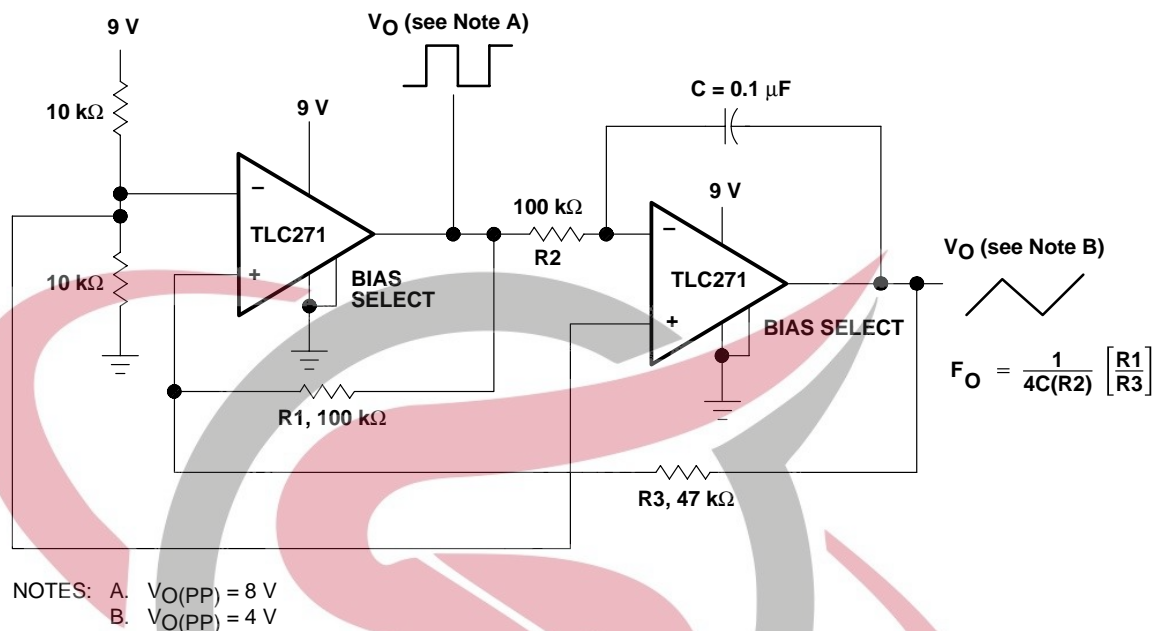
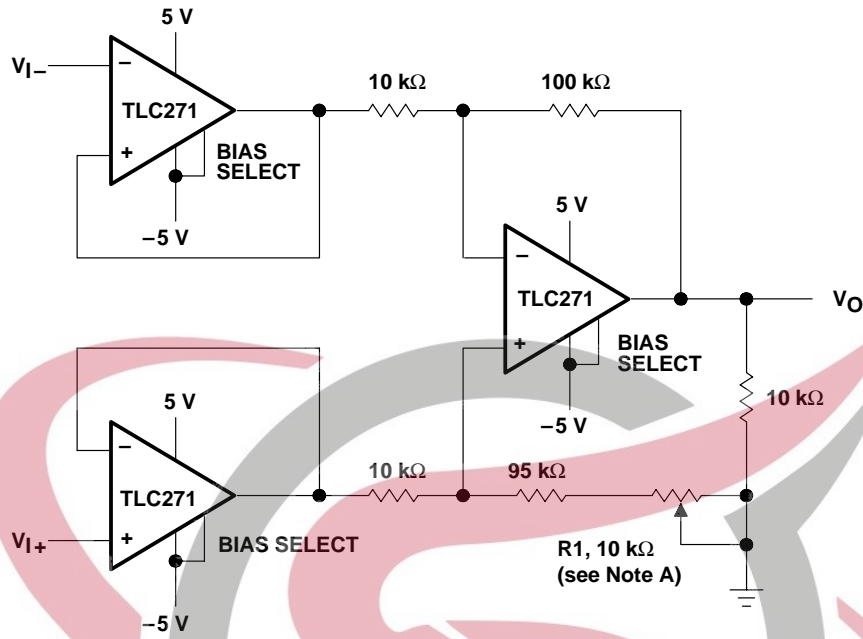

Figure 115. Single-Supply Function Generator

SKYTECH
 ELECTRONIC

APPLICATION INFORMATION (HIGH-BIAS MODE)



NOTE A: CMRR adjustment must be noninductive.

Figure 116. Low-Power Instrumentation Amplifier

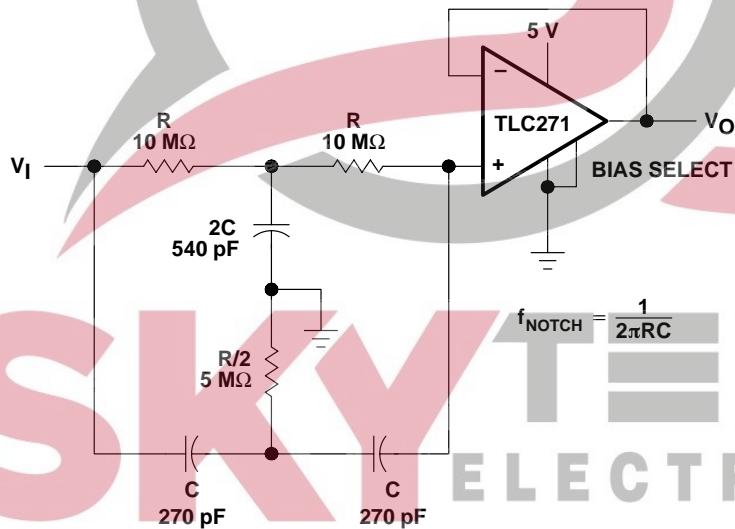
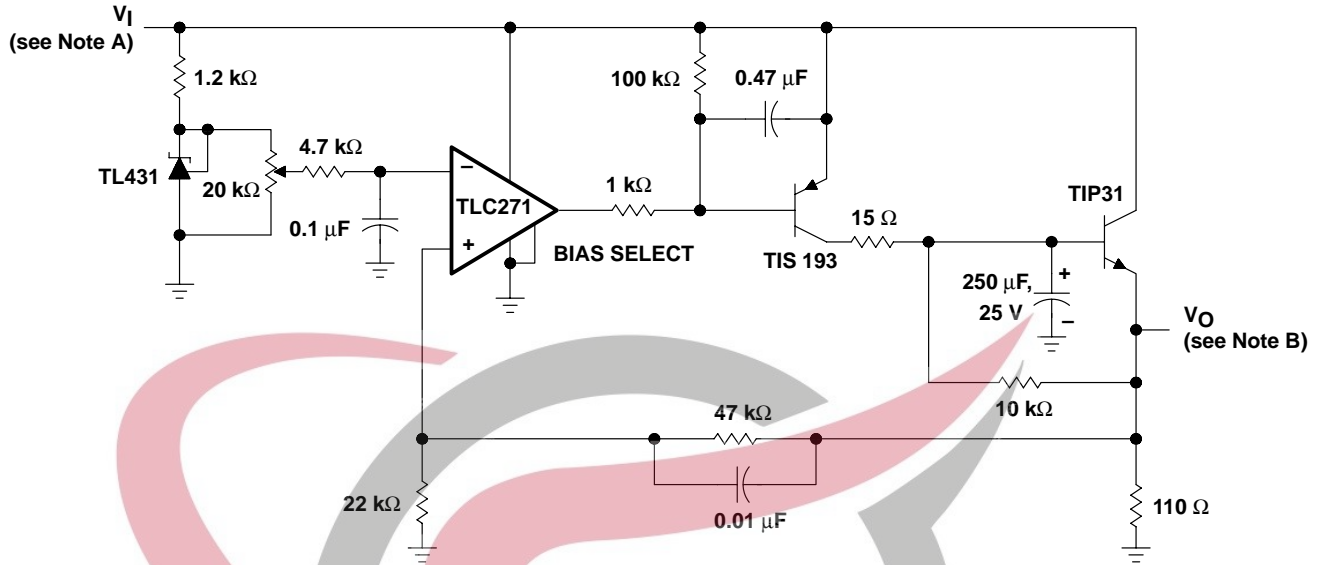

Figure 117. Single-Supply Twin-T Notch Filter

APPLICATION INFORMATION (HIGH-BIAS MODE)



NOTES: A. $V_I = 3.5$ to 15 V
 B. $V_O = 2.0$ V, 0 to 1 A

Figure 118. Logic-Array Power Supply

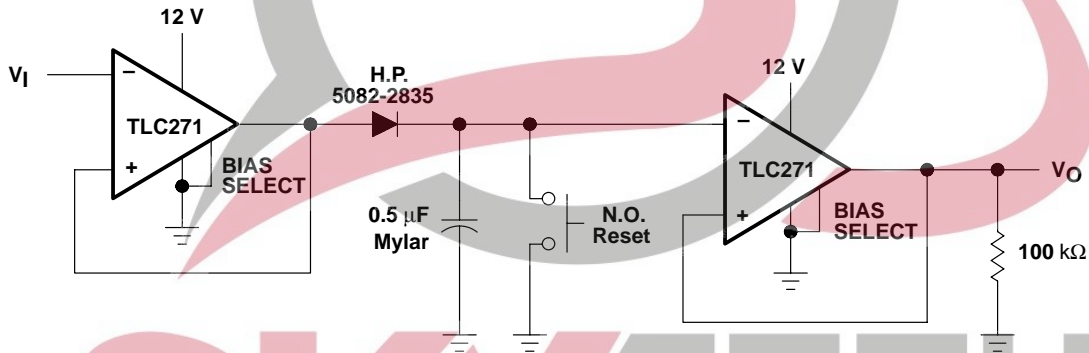
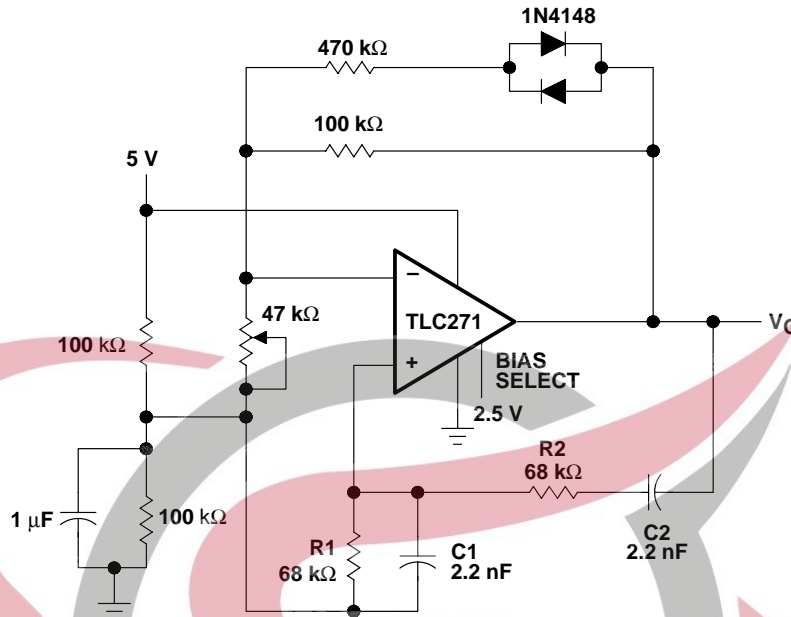

Figure 119. Positive-Peak Detector



APPLICATION INFORMATION (MEDIUM-BIAS MODE)



- NOTES: A. $V_{O(PP)} = 2\text{ V}$
 B. $f_o = \frac{1}{2\pi \sqrt{R1R2C1C2}}$

Figure 120. Wein Oscillator

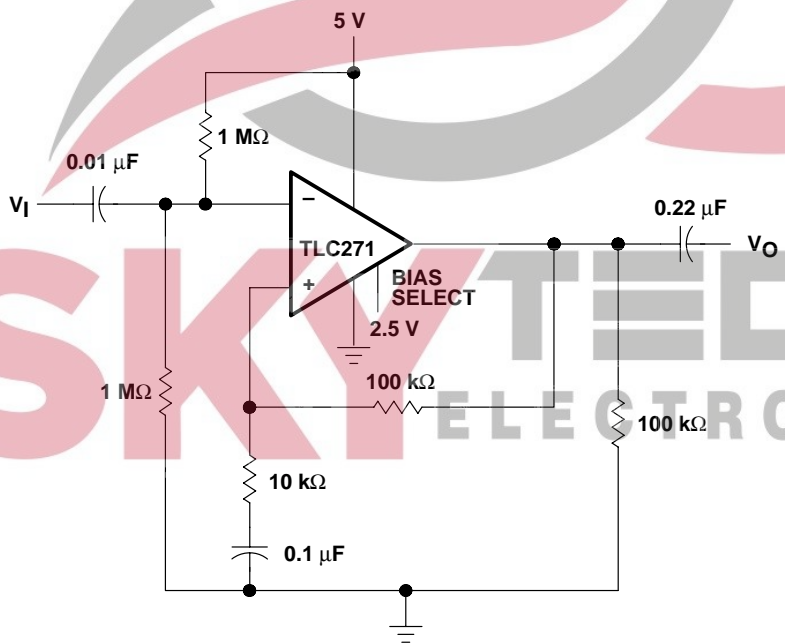
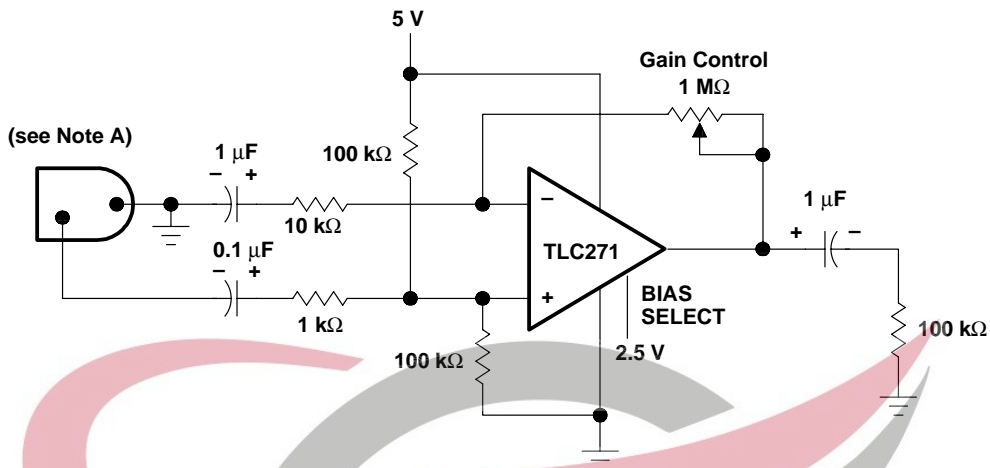

Figure 121. Single-Supply AC Amplifier

APPLICATION INFORMATION (MEDIUM-BIAS MODE)



NOTE A: Low to medium impedance dynamic mike

Figure 122. Microphone Preamplifier

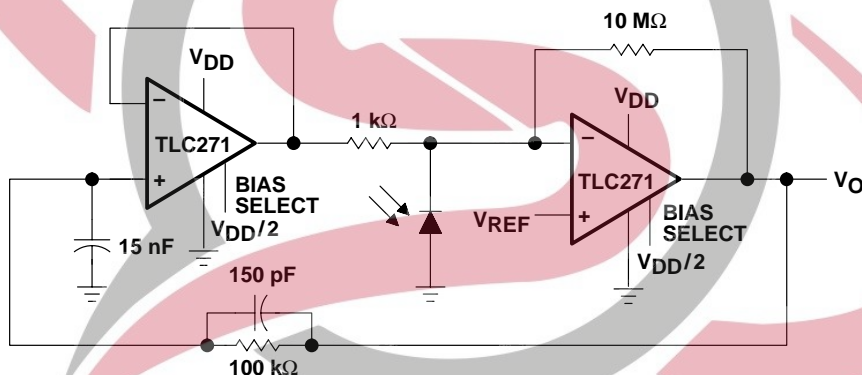

NOTES: A. $V_{DD} = 4 \text{ V to } 15 \text{ V}$
 B. $V_{ref} = 0 \text{ V to } V_{DD} - 2 \text{ V}$

Figure 123. Photo-Diode Amplifier With Ambient Light Rejection

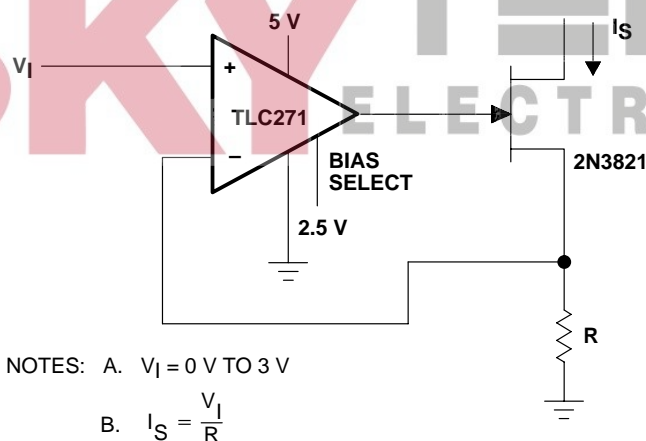

NOTES: A. $V_I = 0 \text{ V TO } 3 \text{ V}$
 B. $I_S = \frac{V_I}{R}$

Figure 124. Precision Low-Current Sink

APPLICATION INFORMATION (LOW-BIAS MODE)

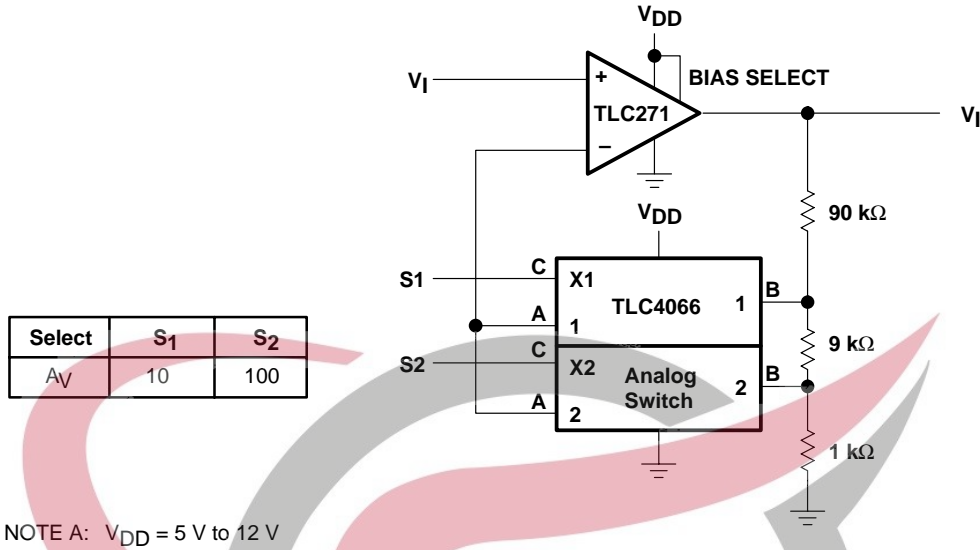

Figure 125. Amplifier With Digital Gain Selection

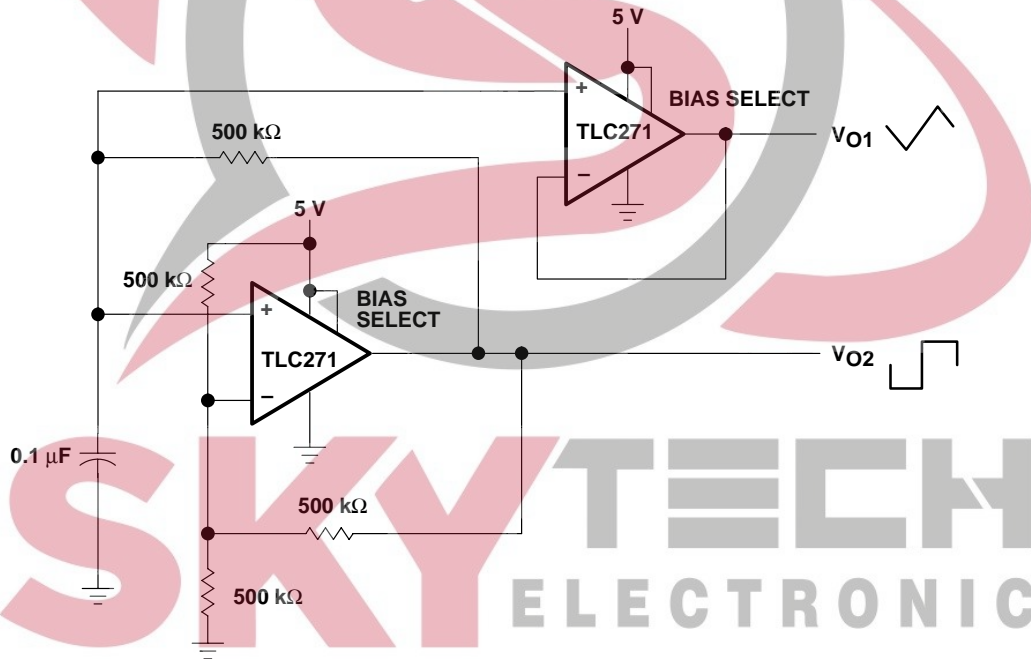
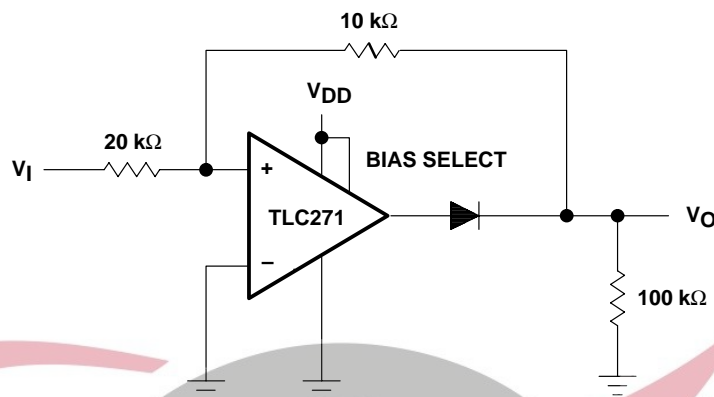

Figure 126. Multivibrator

APPLICATION INFORMATION (LOW-BIAS MODE)



NOTE A: $V_{DD} = 5\text{ V to }16\text{ V}$

Figure 127. Full-Wave Rectifier

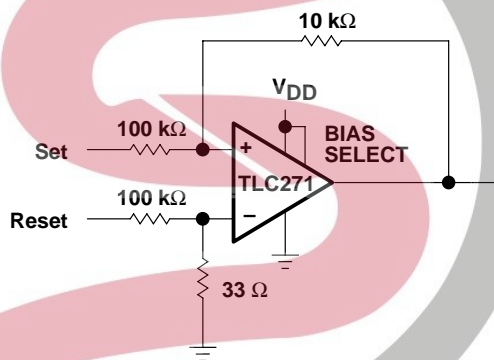

NOTE A: $V_{DD} = 5\text{ V to }16\text{ V}$

Figure 128. Set/Reset Flip-Flop

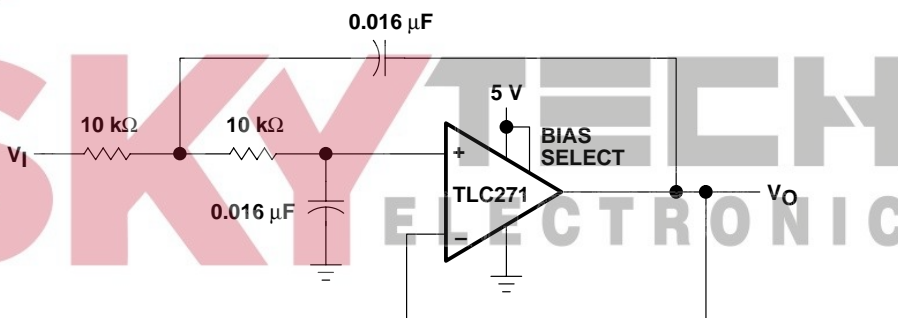

NOTE A: Normalized to $F_C = 1\text{ kHz}$ and $R_L = 10\text{ k}\Omega$

Figure 129. Two-Pole Low-Pass Butterworth Filter

PACKAGING INFORMATION

Orderable Device	Status (1)	Package Type	Package Drawing	Pins	Package Qty	Eco Plan (2)	Lead/Ball Finish (6)	MSL Peak Temp (3)	Op Temp (°C)	Device Marking (4/5)	Samples
TLC271ACD	ACTIVE	SOIC	D	8	75	Green (RoHS & no Sb/Br)	NIPDAU	Level-1-260C-UNLIM	0 to 70	271AC	Samples
TLC271ACDR	ACTIVE	SOIC	D	8	2500	Green (RoHS & no Sb/Br)	NIPDAU	Level-1-260C-UNLIM	0 to 70	271AC	Samples
TLC271ACP	ACTIVE	PDIP	P	8	50	Green (RoHS & no Sb/Br)	NIPDAU	N / A for Pkg Type	0 to 70	TLC271ACP	Samples
TLC271ACPSR	ACTIVE	SO	PS	8	2000	Green (RoHS & no Sb/Br)	NIPDAU	Level-1-260C-UNLIM	0 to 70	P271A	Samples
TLC271AID	ACTIVE	SOIC	D	8	75	Green (RoHS & no Sb/Br)	NIPDAU	Level-1-260C-UNLIM	-40 to 85	271AI	Samples
TLC271AIDG4	ACTIVE	SOIC	D	8	75	Green (RoHS & no Sb/Br)	NIPDAU	Level-1-260C-UNLIM	-40 to 85	271AI	Samples
TLC271AIDR	ACTIVE	SOIC	D	8	2500	Green (RoHS & no Sb/Br)	NIPDAU	Level-1-260C-UNLIM	-40 to 85	271AI	Samples
TLC271AIP	ACTIVE	PDIP	P	8	50	Green (RoHS & no Sb/Br)	NIPDAU	N / A for Pkg Type	-40 to 85	TLC271AIP	Samples
TLC271BCD	ACTIVE	SOIC	D	8	75	Green (RoHS & no Sb/Br)	NIPDAU	Level-1-260C-UNLIM	0 to 70	271BC	Samples
TLC271BCDG4	ACTIVE	SOIC	D	8	75	Green (RoHS & no Sb/Br)	NIPDAU	Level-1-260C-UNLIM	0 to 70	271BC	Samples
TLC271BCDR	ACTIVE	SOIC	D	8	2500	Green (RoHS & no Sb/Br)	NIPDAU	Level-1-260C-UNLIM	0 to 70	271BC	Samples
TLC271BCP	ACTIVE	PDIP	P	8	50	Green (RoHS & no Sb/Br)	NIPDAU	N / A for Pkg Type	0 to 70	TLC271BCP	Samples
TLC271BID	ACTIVE	SOIC	D	8	75	Green (RoHS & no Sb/Br)	NIPDAU	Level-1-260C-UNLIM	-40 to 85	271BI	Samples
TLC271BIDG4	ACTIVE	SOIC	D	8	75	Green (RoHS & no Sb/Br)	NIPDAU	Level-1-260C-UNLIM	-40 to 85	271BI	Samples
TLC271BIDR	ACTIVE	SOIC	D	8	2500	Green (RoHS & no Sb/Br)	NIPDAU	Level-1-260C-UNLIM	-40 to 85	271BI	Samples
TLC271BIP	ACTIVE	PDIP	P	8	50	Green (RoHS & no Sb/Br)	NIPDAU	N / A for Pkg Type	-40 to 85	TLC271BIP	Samples
TLC271CD	ACTIVE	SOIC	D	8	75	Green (RoHS & no Sb/Br)	NIPDAU	Level-1-260C-UNLIM	0 to 70	271C	Samples

Orderable Device	Status (1)	Package Type	Package Drawing	Pins	Package Qty	Eco Plan (2)	Lead/Ball Finish (6)	MSL Peak Temp (3)	Op Temp (°C)	Device Marking (4/5)	Samples
TLC271CDR	ACTIVE	SOIC	D	8	2500	Green (RoHS & no Sb/Br)	NIPDAU	Level-1-260C-UNLIM	0 to 70	271C	Samples
TLC271CDRG4	ACTIVE	SOIC	D	8	2500	Green (RoHS & no Sb/Br)	NIPDAU	Level-1-260C-UNLIM	0 to 70	271C	Samples
TLC271CP	ACTIVE	PDIP	P	8	50	Green (RoHS & no Sb/Br)	NIPDAU	N / A for Pkg Type	0 to 70	TLC271CP	Samples
TLC271CPSR	ACTIVE	SO	PS	8	2000	Green (RoHS & no Sb/Br)	NIPDAU	Level-1-260C-UNLIM	0 to 70	P271	Samples
TLC271CPW	ACTIVE	TSSOP	PW	8	150	Green (RoHS & no Sb/Br)	NIPDAU	Level-1-260C-UNLIM	0 to 70	P271	Samples
TLC271CPWR	ACTIVE	TSSOP	PW	8	2000	Green (RoHS & no Sb/Br)	NIPDAU	Level-1-260C-UNLIM	0 to 70	P271	Samples
TLC271CPWRG4	ACTIVE	TSSOP	PW	8	2000	Green (RoHS & no Sb/Br)	NIPDAU	Level-1-260C-UNLIM	0 to 70	P271	Samples
TLC271ID	ACTIVE	SOIC	D	8	75	Green (RoHS & no Sb/Br)	NIPDAU	Level-1-260C-UNLIM	-40 to 85	271I	Samples
TLC271IDR	ACTIVE	SOIC	D	8	2500	Green (RoHS & no Sb/Br)	NIPDAU	Level-1-260C-UNLIM	-40 to 85	271I	Samples
TLC271IDRG4	ACTIVE	SOIC	D	8	2500	Green (RoHS & no Sb/Br)	NIPDAU	Level-1-260C-UNLIM	-40 to 85	271I	Samples
TLC271IP	ACTIVE	PDIP	P	8	50	Green (RoHS & no Sb/Br)	NIPDAU	N / A for Pkg Type	-40 to 85	TLC271IP	Samples
TLC271MDR	ACTIVE	SOIC	D	8	2500	Green (RoHS & no Sb/Br)	NIPDAU	Level-1-260C-UNLIM	-55 to 125	271M	Samples
TLC271MDRG4	ACTIVE	SOIC	D	8	2500	Green (RoHS & no Sb/Br)	NIPDAU	Level-1-260C-UNLIM	-55 to 125	271M	Samples

(1) The marketing status values are defined as follows:

ACTIVE: Product device recommended for new designs.

LIFEBUY: TI has announced that the device will be discontinued, and a lifetime-buy period is in effect.

NRND: Not recommended for new designs. Device is in production to support existing customers, but TI does not recommend using this part in a new design.

PREVIEW: Device has been announced but is not in production. Samples may or may not be available.

OBsolete: TI has discontinued the production of the device.

(2) **RoHS:** TI defines "RoHS" to mean semiconductor products that are compliant with the current EU RoHS requirements for all 10 RoHS substances, including the requirement that RoHS substance do not exceed 0.1% by weight in homogeneous materials. Where designed to be soldered at high temperatures, "RoHS" products are suitable for use in specified lead-free processes. TI may reference these types of products as "Pb-Free".

RoHS Exempt: TI defines "RoHS Exempt" to mean products that contain lead but are compliant with EU RoHS pursuant to a specific EU RoHS exemption.

Green: TI defines "Green" to mean the content of Chlorine (Cl) and Bromine (Br) based flame retardants meet JS709B low halogen requirements of ≤ 1000 ppm threshold. Antimony trioxide based flame retardants must also meet the ≤ 1000 ppm threshold requirement.

(3) MSL, Peak Temp. - The Moisture Sensitivity Level rating according to the JEDEC industry standard classifications, and peak solder temperature.

(4) There may be additional marking, which relates to the logo, the lot trace code information, or the environmental category on the device.

(5) Multiple Device Markings will be inside parentheses. Only one Device Marking contained in parentheses and separated by a "~" will appear on a device. If a line is indented then it is a continuation of the previous line and the two combined represent the entire Device Marking for that device.

(6) Lead/Ball Finish - Orderable Devices may have multiple material finish options. Finish options are separated by a vertical ruled line. Lead/Ball Finish values may wrap to two lines if the finish value exceeds the maximum column width.

Important Information and Disclaimer: The information provided on this page represents TI's knowledge and belief as of the date that it is provided. TI bases its knowledge and belief on information provided by third parties, and makes no representation or warranty as to the accuracy of such information. Efforts are underway to better integrate information from third parties. TI has taken and continues to take reasonable steps to provide representative and accurate information but may not have conducted destructive testing or chemical analysis on incoming materials and chemicals. TI and TI suppliers consider certain information to be proprietary, and thus CAS numbers and other limited information may not be available for release.

In no event shall TI's liability arising out of such information exceed the total purchase price of the TI part(s) at issue in this document sold by TI to Customer on an annual basis.



SKYTECH
ELECTRONIC

TAPE AND REEL INFORMATION

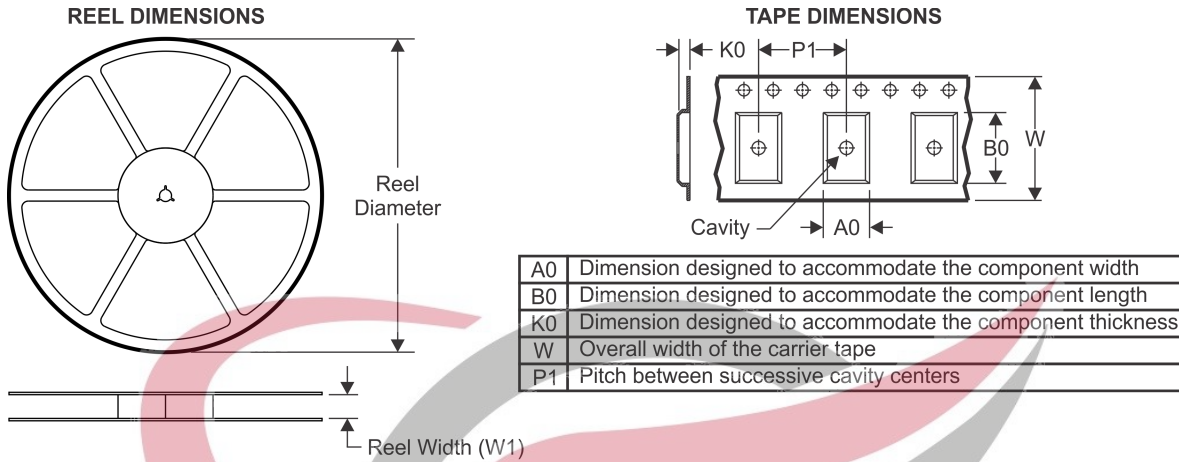

QUADRANT ASSIGNMENTS FOR PIN 1 ORIENTATION IN TAPE

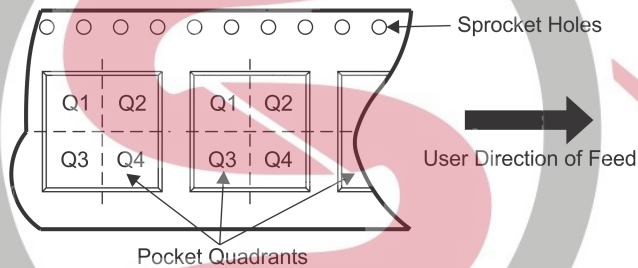

*All dimensions are nominal

Device	Package Type	Package Drawing	Pins	SPQ	Reel Diameter (mm)	Reel Width W1 (mm)	A0 (mm)	B0 (mm)	K0 (mm)	P1 (mm)	W (mm)	Pin1 Quadrant
TLC271ACDR	SOIC	D	8	2500	330.0	12.4	6.4	5.2	2.1	8.0	12.0	Q1
TLC271ACPSR	SO	PS	8	2000	330.0	16.4	8.35	6.6	2.5	12.0	16.0	Q1
TLC271AIDR	SOIC	D	8	2500	330.0	12.4	6.4	5.2	2.1	8.0	12.0	Q1
TLC271BCDR	SOIC	D	8	2500	330.0	12.4	6.4	5.2	2.1	8.0	12.0	Q1
TLC271BIDR	SOIC	D	8	2500	330.0	12.4	6.4	5.2	2.1	8.0	12.0	Q1
TLC271CDR	SOIC	D	8	2500	330.0	12.4	6.4	5.2	2.1	8.0	12.0	Q1
TLC271CPWR	TSSOP	PW	8	2000	330.0	12.4	7.0	3.6	1.6	8.0	12.0	Q1
TLC271IDR	SOIC	D	8	2500	330.0	12.4	6.4	5.2	2.1	8.0	12.0	Q1
TLC271MDR	SOIC	D	8	2500	330.0	12.4	6.4	5.2	2.1	8.0	12.0	Q1

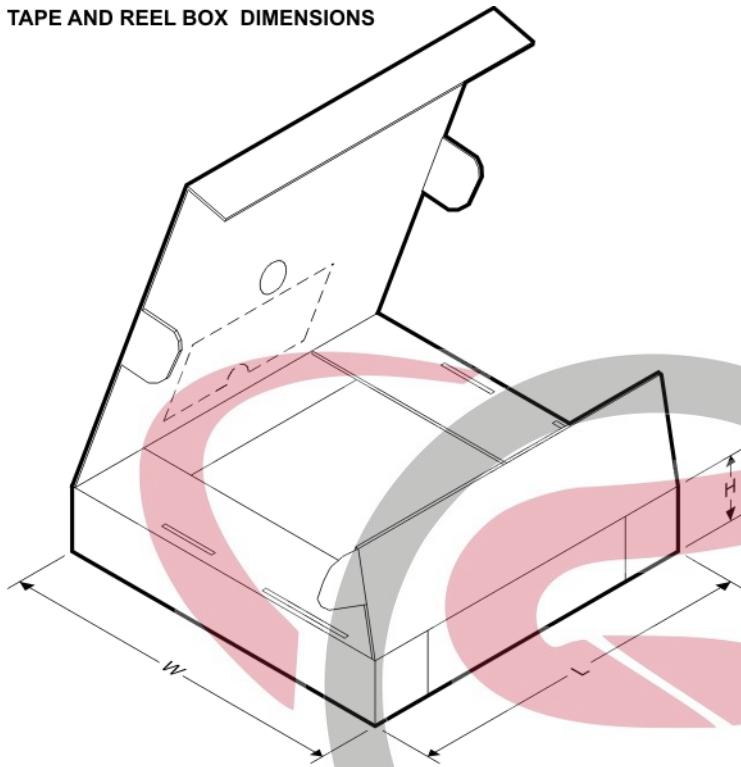
TAPE AND REEL BOX DIMENSIONS

*All dimensions are nominal

Device	Package Type	Package Drawing	Pins	SPQ	Length (mm)	Width (mm)	Height (mm)
TLC271ACDR	SOIC	D	8	2500	340.5	338.1	20.6
TLC271ACPSR	SO	PS	8	2000	367.0	367.0	38.0
TLC271AIDR	SOIC	D	8	2500	340.5	338.1	20.6
TLC271BCDR	SOIC	D	8	2500	340.5	338.1	20.6
TLC271BIDR	SOIC	D	8	2500	340.5	338.1	20.6
TLC271CDR	SOIC	D	8	2500	340.5	338.1	20.6
TLC271CPWR	TSSOP	PW	8	2000	367.0	367.0	35.0
TLC271IDR	SOIC	D	8	2500	340.5	338.1	20.6
TLC271MDR	SOIC	D	8	2500	350.0	350.0	43.0

SKY ELECTRONIC



D0008A

PACKAGE OUTLINE

SOIC - 1.75 mm max height

SMALL OUTLINE INTEGRATED CIRCUIT

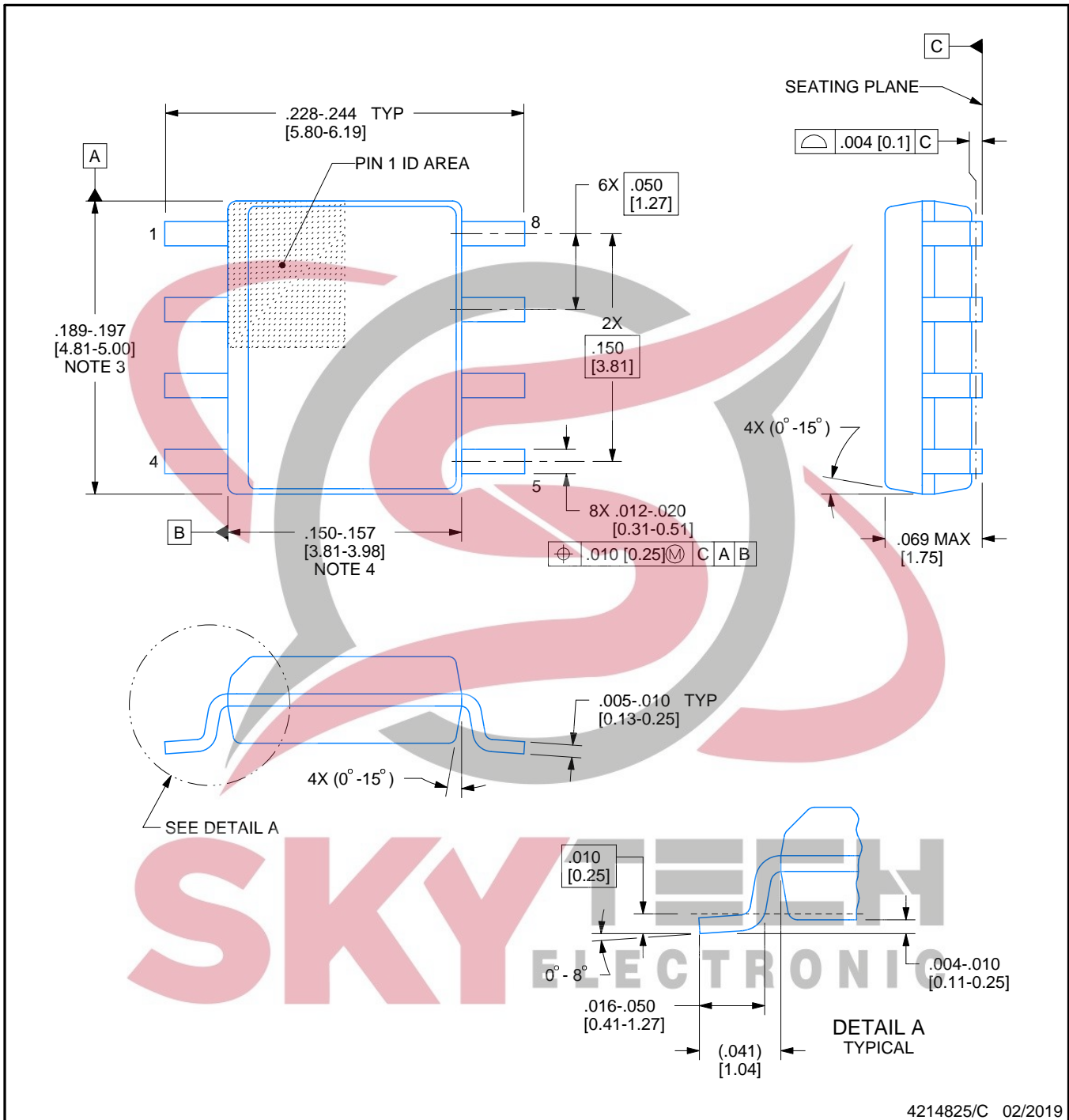

NOTES:

1. Linear dimensions are in inches [millimeters]. Dimensions in parenthesis are for reference only. Controlling dimensions are in inches. Dimensioning and tolerancing per ASME Y14.5M.
2. This drawing is subject to change without notice.
3. This dimension does not include mold flash, protrusions, or gate burrs. Mold flash, protrusions, or gate burrs shall not exceed .006 [0.15] per side.
4. This dimension does not include interlead flash.
5. Reference JEDEC registration MS-012, variation AA.

EXAMPLE BOARD LAYOUT

D0008A

SOIC - 1.75 mm max height

SMALL OUTLINE INTEGRATED CIRCUIT

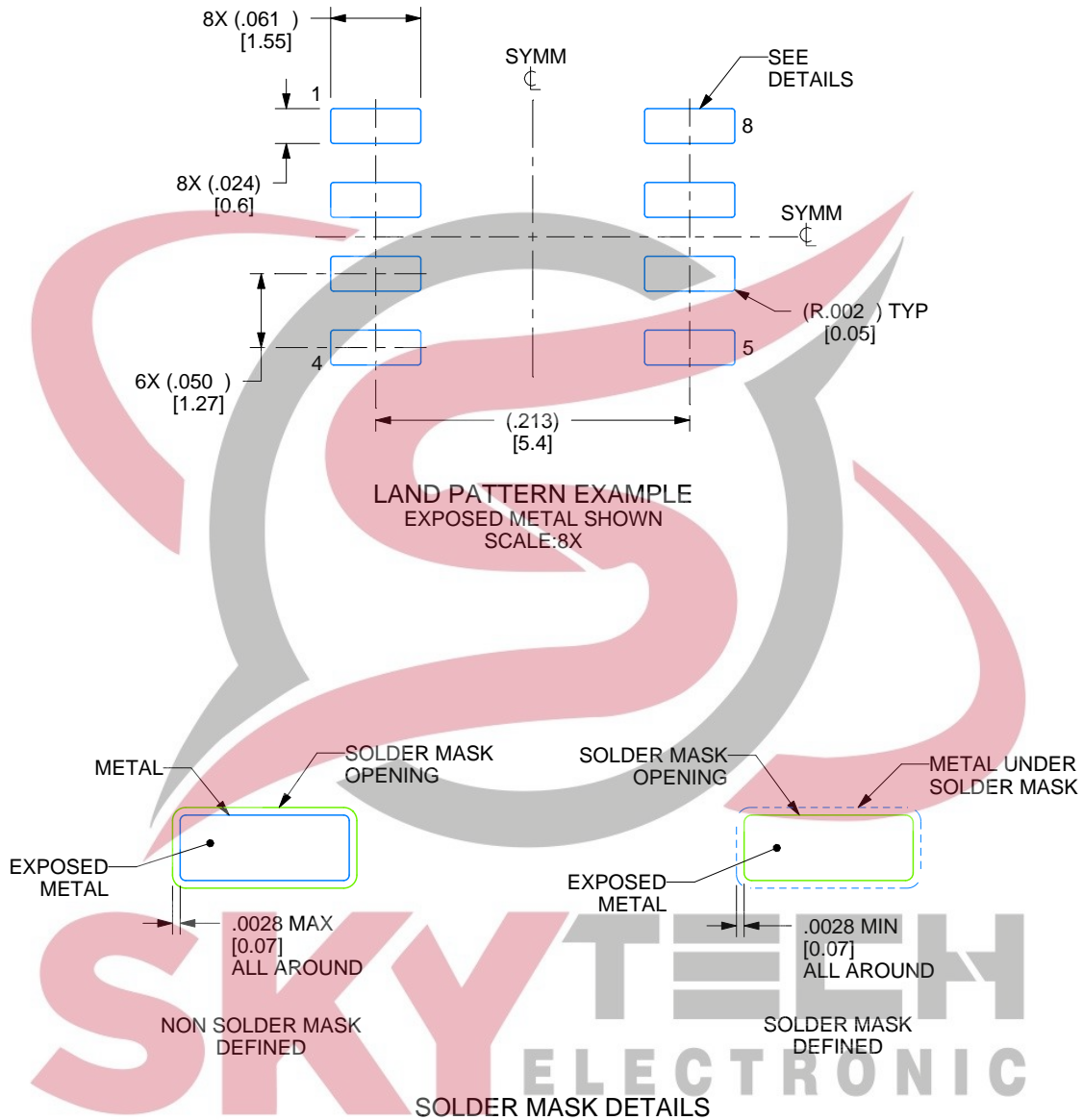

4214825/C 02/2019

NOTES: (continued)

6. Publication IPC-7351 may have alternate designs.
7. Solder mask tolerances between and around signal pads can vary based on board fabrication site.

EXAMPLE STENCIL DESIGN

D0008A

SOIC - 1.75 mm max height

SMALL OUTLINE INTEGRATED CIRCUIT

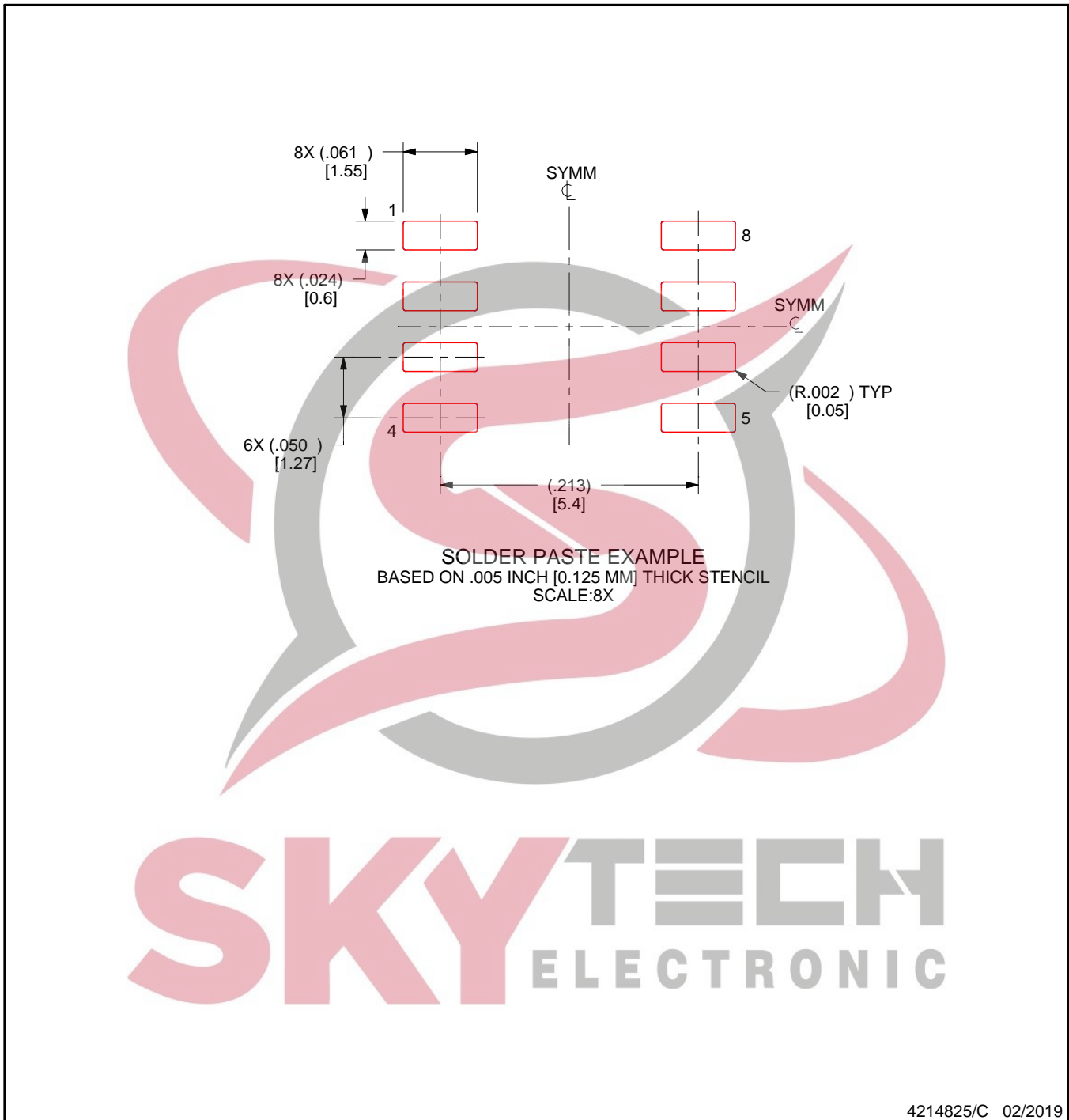

NOTES: (continued)

8. Laser cutting apertures with trapezoidal walls and rounded corners may offer better paste release. IPC-7525 may have alternate design recommendations.
9. Board assembly site may have different recommendations for stencil design.

MECHANICAL DATA

PS (R-PDSO-G8)

PLASTIC SMALL-OUTLINE PACKAGE

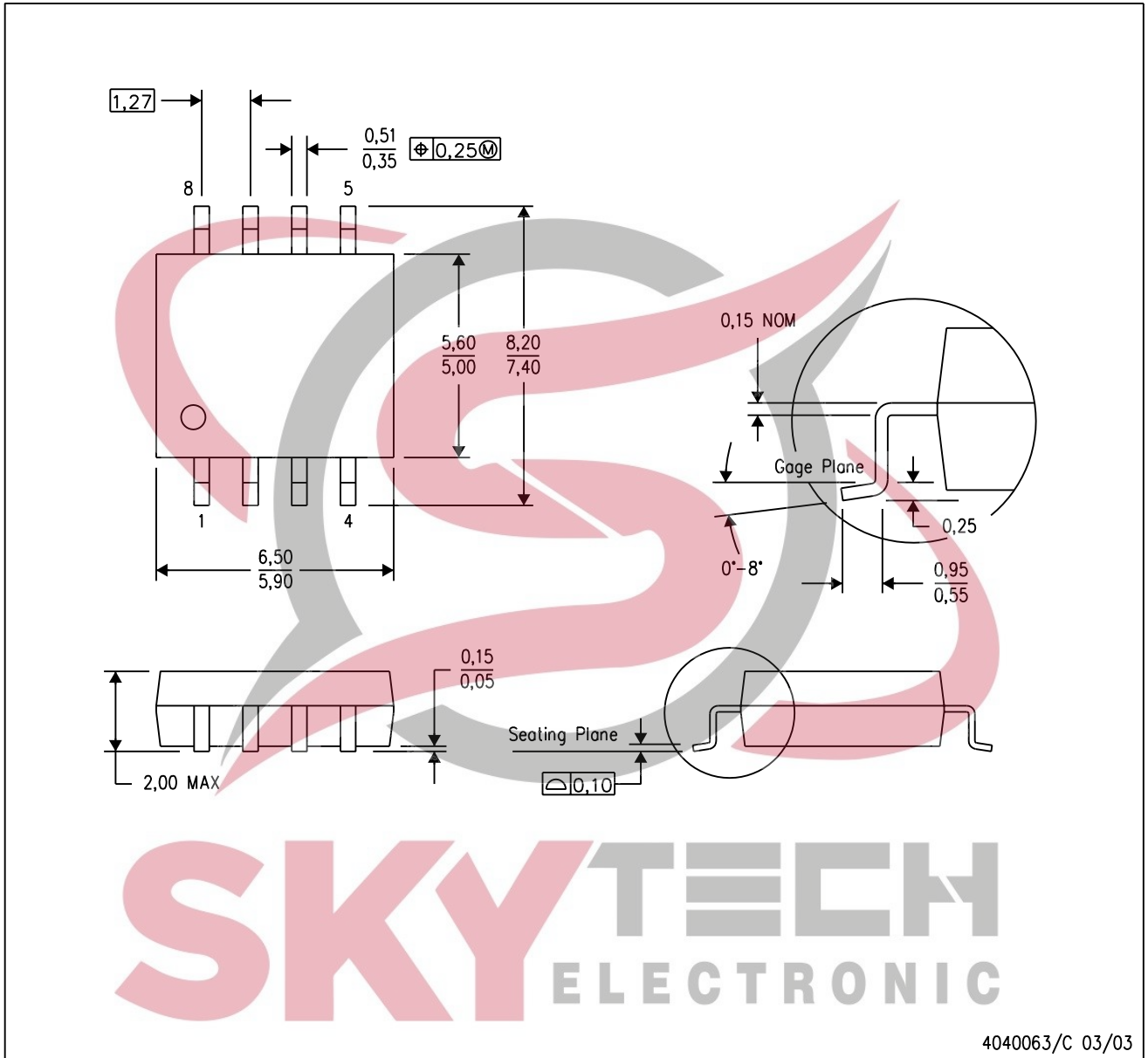

- NOTES:
- A. All linear dimensions are in millimeters.
 - B. This drawing is subject to change without notice.
 - C. Body dimensions do not include mold flash or protrusion, not to exceed 0,15.

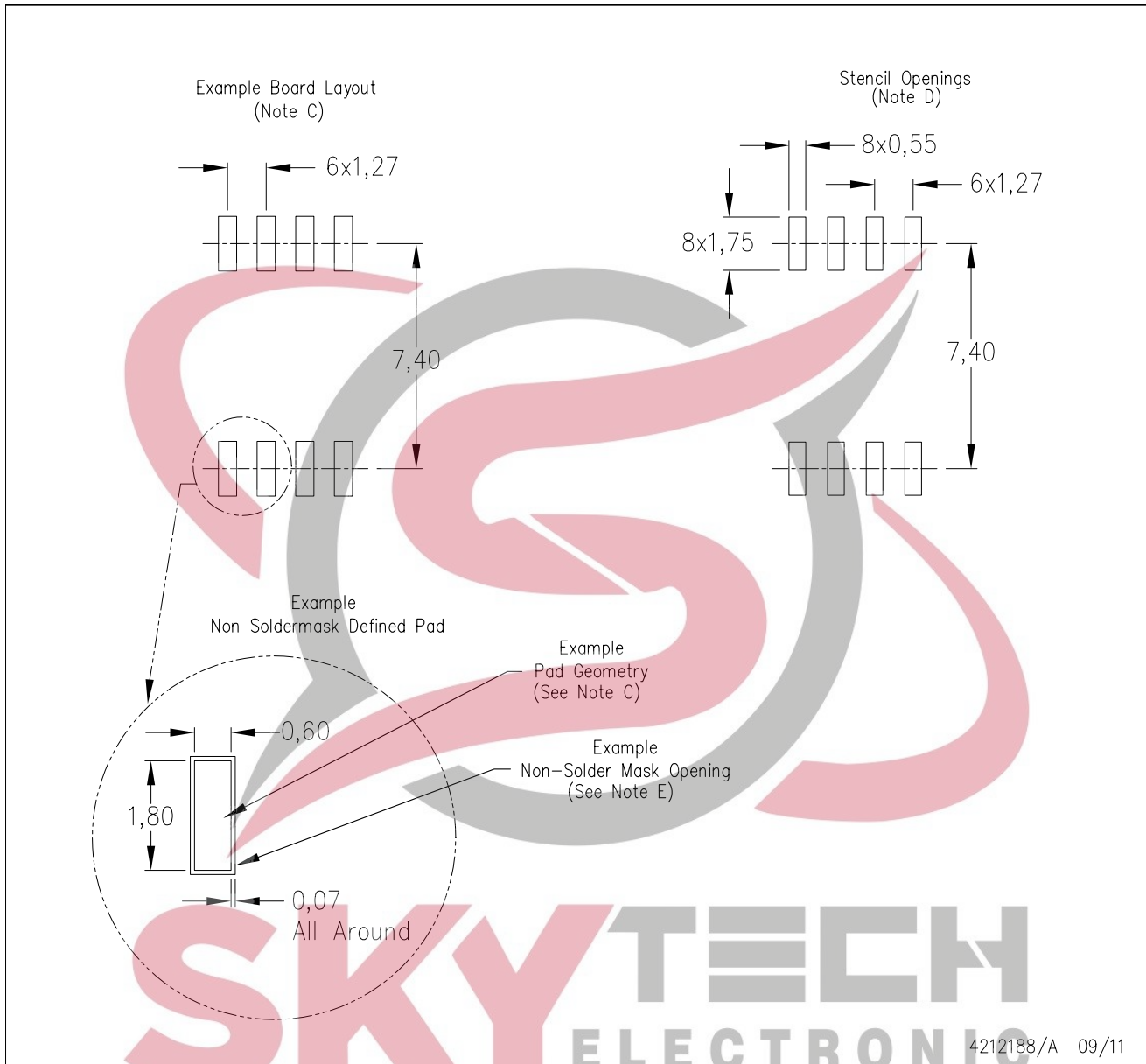

- NOTES:
- A. All linear dimensions are in millimeters.
 - B. This drawing is subject to change without notice.
 - C. Publication IPC-7351 is recommended for alternate designs.
 - D. Laser cutting apertures with trapezoidal walls and also rounding corners will offer better paste release. Customers should contact their board assembly site for stencil design recommendations. Refer to IPC-7525 for other stencil recommendations.
 - E. Customers should contact their board fabrication site for solder mask tolerances between and around signal pads.

P (R-PDIP-T8)

PLASTIC DUAL-IN-LINE PACKAGE

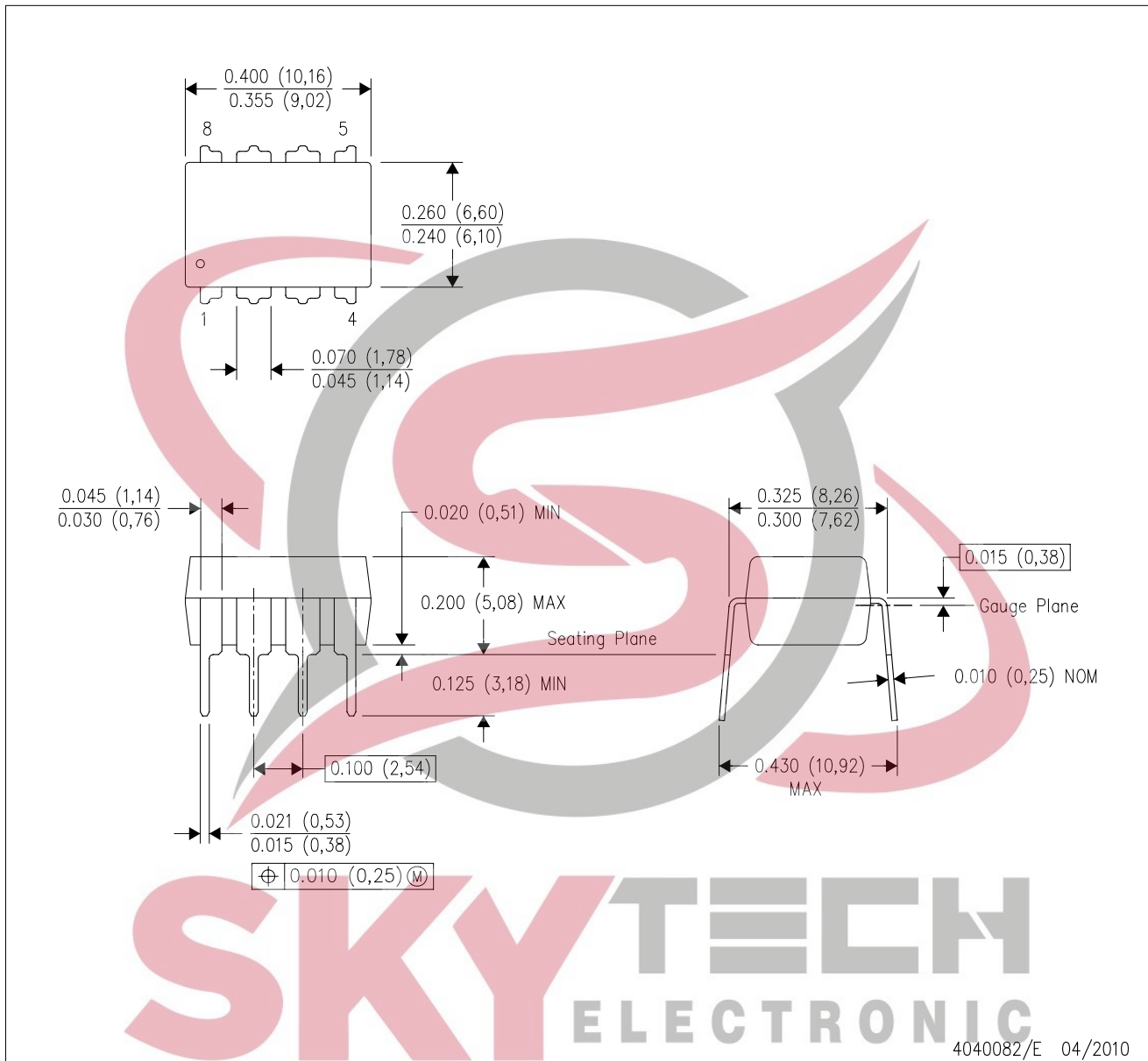

- NOTES:
- A. All linear dimensions are in inches (millimeters).
 - B. This drawing is subject to change without notice.
 - C. Falls within JEDEC MS-001 variation BA.

PW0008A



PACKAGE OUTLINE
TSSOP - 1.2 mm max height

SMALL OUTLINE PACKAGE

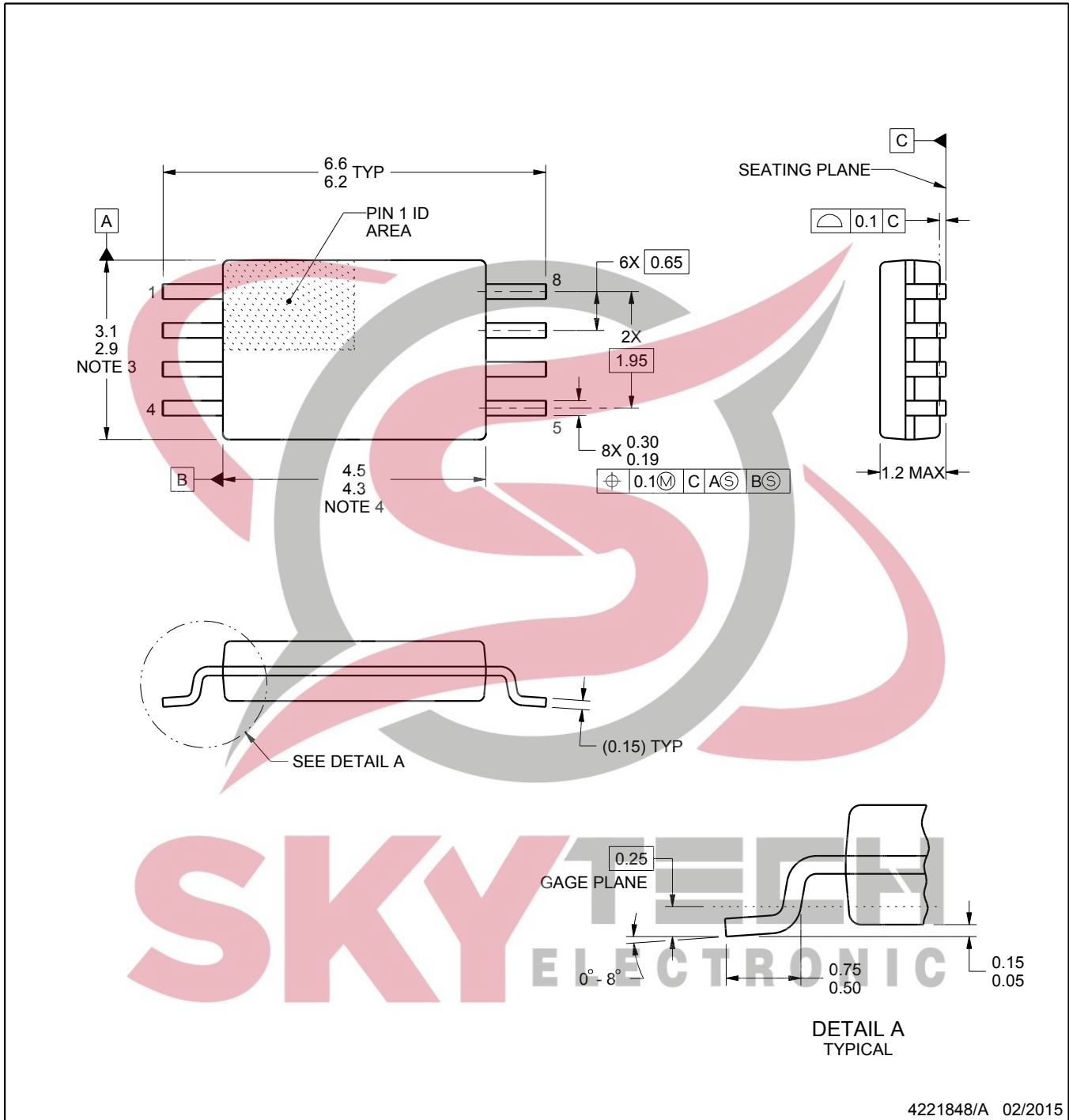

NOTES:

1. All linear dimensions are in millimeters. Any dimensions in parenthesis are for reference only. Dimensioning and tolerancing per ASME Y14.5M.
2. This drawing is subject to change without notice.
3. This dimension does not include mold flash, protrusions, or gate burrs. Mold flash, protrusions, or gate burrs shall not exceed 0.15 mm per side.
4. This dimension does not include interlead flash. Interlead flash shall not exceed 0.25 mm per side.
5. Reference JEDEC registration MO-153, variation AA.

EXAMPLE BOARD LAYOUT

PW0008A

TSSOP - 1.2 mm max height

SMALL OUTLINE PACKAGE

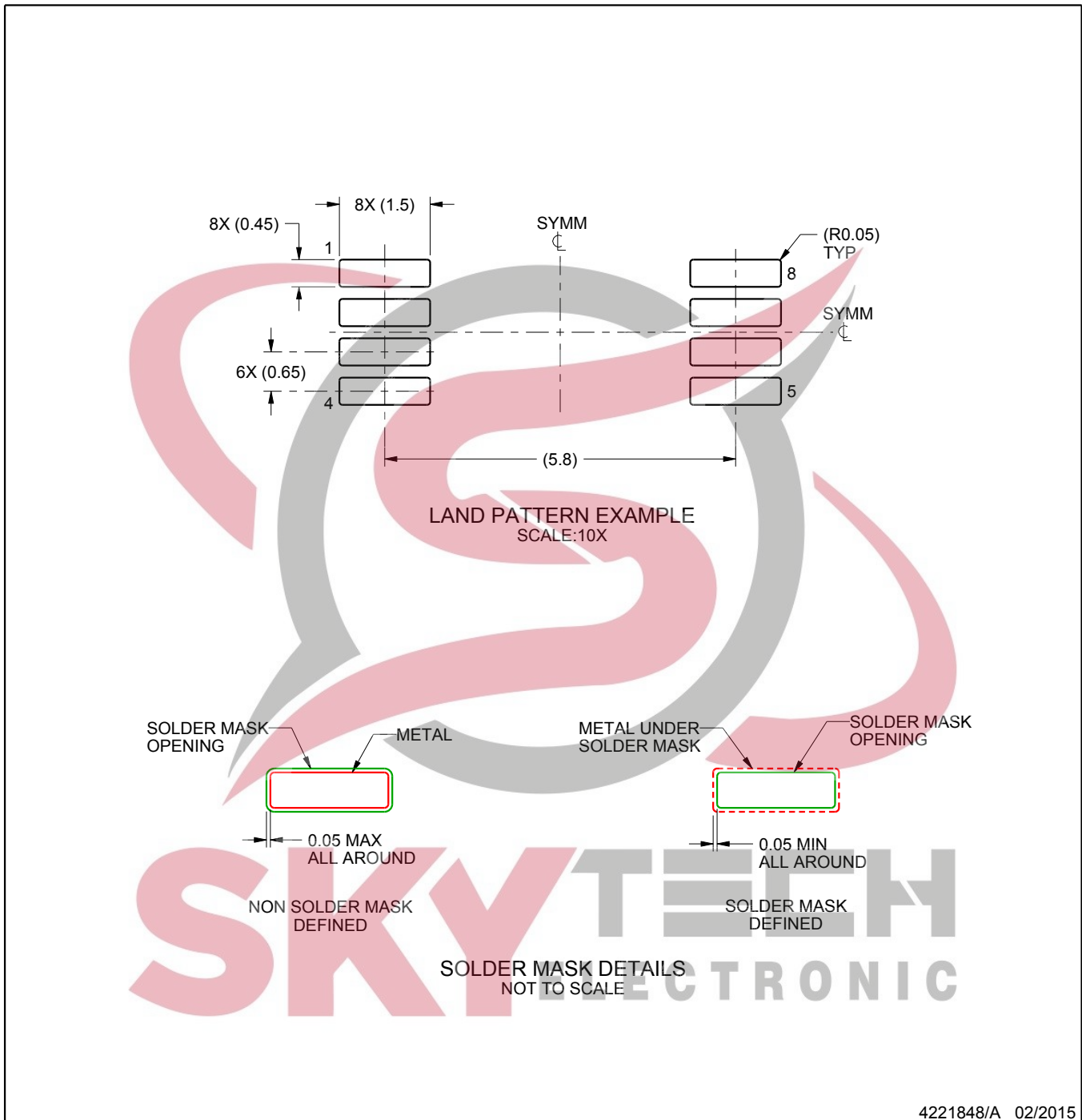

NOTES: (continued)

- 6. Publication IPC-7351 may have alternate designs.
- 7. Solder mask tolerances between and around signal pads can vary based on board fabrication site.

EXAMPLE STENCIL DESIGN

PW0008A

TSSOP - 1.2 mm max height

SMALL OUTLINE PACKAGE

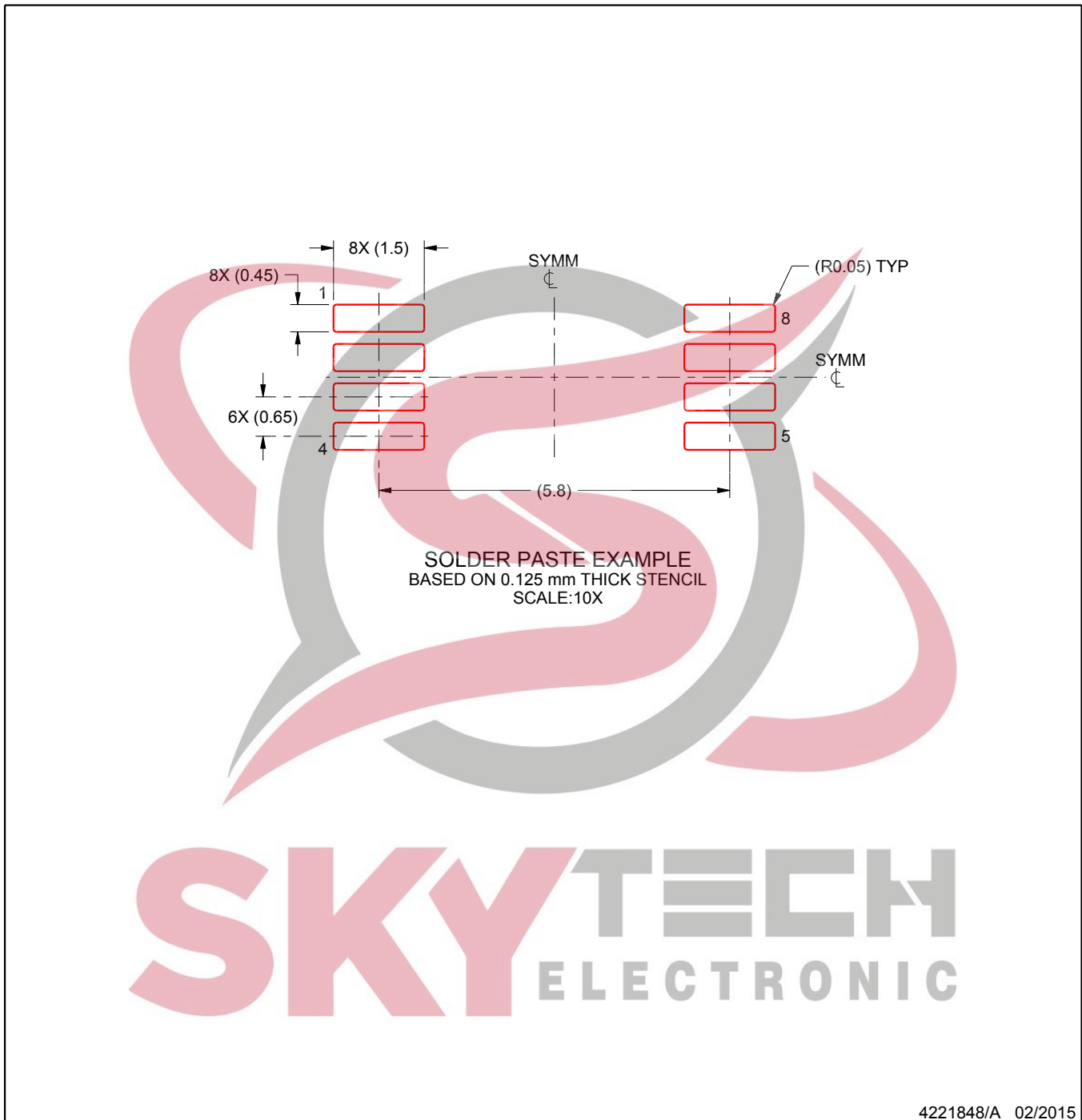

NOTES: (continued)

8. Laser cutting apertures with trapezoidal walls and rounded corners may offer better paste release. IPC-7525 may have alternate design recommendations.
9. Board assembly site may have different recommendations for stencil design.

IMPORTANT NOTICE AND DISCLAIMER

TI PROVIDES TECHNICAL AND RELIABILITY DATA (INCLUDING DATASHEETS), DESIGN RESOURCES (INCLUDING REFERENCE DESIGNS), APPLICATION OR OTHER DESIGN ADVICE, WEB TOOLS, SAFETY INFORMATION, AND OTHER RESOURCES "AS IS" AND WITH ALL FAULTS, AND DISCLAIMS ALL WARRANTIES, EXPRESS AND IMPLIED, INCLUDING WITHOUT LIMITATION ANY IMPLIED WARRANTIES OF MERCHANTABILITY, FITNESS FOR A PARTICULAR PURPOSE OR NON-INFRINGEMENT OF THIRD PARTY INTELLECTUAL PROPERTY RIGHTS.

These resources are intended for skilled developers designing with TI products. You are solely responsible for (1) selecting the appropriate TI products for your application, (2) designing, validating and testing your application, and (3) ensuring your application meets applicable standards, and any other safety, security, or other requirements. These resources are subject to change without notice. TI grants you permission to use these resources only for development of an application that uses the TI products described in the resource. Other reproduction and display of these resources is prohibited. No license is granted to any other TI intellectual property right or to any third party intellectual property right. TI disclaims responsibility for, and you will fully indemnify TI and its representatives against, any claims, damages, costs, losses, and liabilities arising out of your use of these resources.

TI's products are provided subject to TI's Terms of Sale (www.ti.com/legal/termsofsale.html) or other applicable terms available either on ti.com or provided in conjunction with such TI products. TI's provision of these resources does not expand or otherwise alter TI's applicable warranties or warranty disclaimers for TI products.

Mailing Address: Texas Instruments, Post Office Box 655303, Dallas, Texas 75265
Copyright © 2020, Texas Instruments Incorporated



SKYTECH
ELECTRONIC